

Professional Tools
for Maximum Performance



www.promaxusatools.com



Professional Tools

Developed in the USA some 26 years ago, PROMAX USA Tools have always subscribed to the highest industry standards to meet with the demands of professionals in the diverse industries of Automotive, Oil & Gas, Mining, Ship Building and Manufacturing.

Promax USA Chrome and Impact Sockets & Accessories are widely recognized and quoted as the standards by which others are judged. Made to exacting specifications, the design, materials and processes are painstakingly monitored to ensure you have the best. Our much applauded IMPACT range is forged from chrome-molybdenum alloy steel, renowned for its strength and durability. The integrity of which is assured in our drop-forged process and precise application of heat and surface durability. The application of heat and surface hardening treatments to delivery sockets for maximum material strength, hardness and surface durability. PROMAX Impact Sockets are made to federal Specification GGG-W-660A and DIN 3121 & 3219.



WARNING!

Wear safety goggles at all time. (User and bystanders). Do not use chrome or handtools with power wrenches
Use only impact sockets and accessories with power impact wrenches

Contents

Hand Sockets and Accessories	03
Impact Sockets and Accessories	15
Wrenches	65
Torque Wrenches	85
Screwdriver	99
Pipe Wrence	105
Conversion Tables	109



WARNING!

Wear safety goggles at all time. (User and bystanders). Do not use chrome or handtools with power wrenches.
Use only impact sockets and accessories with power impact wrenches.



**HAND
SOCKETS
AND
ACCESSORIES**

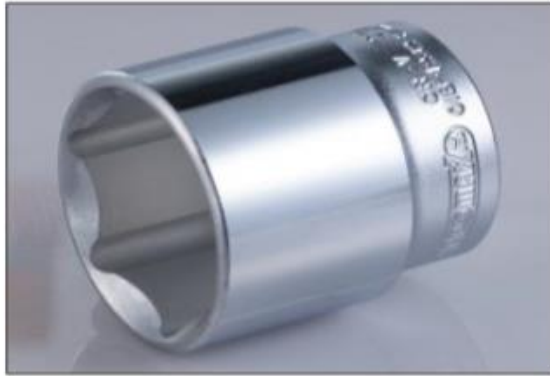

HAND SOCKETS & ACCESSORIES

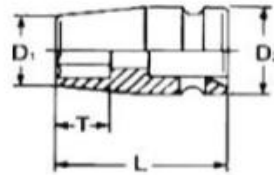

► 1/2" Drive Hexagon Regular Sockets

Stock Code	Size	L (MM)	T (MM)	D1 (MM)	D2 (MM)	Qty (Per Box) pcs	Weight (Per Pce) g
01B-1208	8mm	40	9.5	12	22.5	12	56.0
01B-1209	9mm	40	11	13.2	22.5	12	56.0
01B-1210	10mm	40	13.5	14.6	22.5	12	56.0
01B-1211	11mm	40	15	16.2	22.5	12	59.0
01B-1212	12mm	40	15	17.4	22.5	12	59.0
01B-1213	13mm	40	15	18.8	22.5	12	59.0
01B-1214	14mm	40	15	20	22.5	12	61.0
01B-1215	15mm	40	15	22	23	12	63.0
01B-1216	16mm	40	15	22.5	23	12	66.0
01B-1217	17mm	40	15	24	23	12	66.0
01B-1218	18mm	40	15	25.3	23	12	66.0
01B-1219	19mm	40	15	26.7	23	12	66.0
01B-1220	20mm	40	15	28	23	12	72.0
01B-1221	21mm	40	15	29.2	23	12	75.0
01B-1222	22mm	40	16	30.3	24	6	86.0
01B-1223	23mm	43	18	31.6	25	6	88.0
01B-1224	24mm	43	18	32.8	26	6	96.0
01B-1225	25mm	43	18	34	28	6	105.0
01B-1226	26mm	43	18	35.2	28	6	110.0
01B-1227	27mm	43	18	36.7	29	12	125.0
01B-1228	28mm	43	18	37.7	30	12	140.0
01B-1229	29mm	43	18	39	31	12	145.0
01B-1230	30mm	43	18	40.2	31	12	150.0
01B-1232	32mm	43	18	43	31	12	180.0



www.promaxusa.com



WARNING!

Wear safety goggles at all time. [User and bystanders]. Do not use chrome or handtools with power wrenches. Use only impact sockets and accessories with power impact wrenches.

HAND SOCKETS & ACCESSORIES

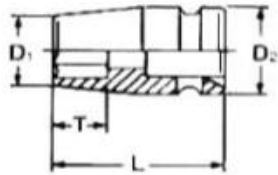

► 1/2" Drive Bi-Hexagon Regular Sockets

Stock Code	Size	L (MM)	T (MM)	D1 (MM)	D2 (MM)	Qty (Per Box) pcs	Weight (Per Pce) g
04B-1208	8mm	40	9.5	12	22.5	12	56.0
04B-1209	9mm	40	11	13.2	22.5	12	56.0
04B-1210	10mm	40	13.5	14.6	22.5	12	56.0
04B-1211	11mm	40	15	16.2	22.5	12	59.0
04B-1212	12mm	40	15	17.4	22.5	12	59.0
04B-1213	13mm	40	15	18.8	22.5	12	59.0
04B-1214	14mm	40	15	20	22.5	12	61.0
04B-1215	15mm	40	15	22	23	12	63.0
04B-1216	16mm	40	15	22.5	23	12	66.0
04B-1217	17mm	40	15	24	23	12	66.0
04B-1218	18mm	40	15	25.3	23	12	66.0
04B-1219	19mm	40	15	26.7	23	12	66.0
04B-1220	20mm	40	15	28	23	12	72.0
04B-1221	21mm	40	15	29.2	23	12	75.0
04B-1222	22mm	40	16	30.3	24	6	86.0
04B-1223	23mm	43	18	31.6	25	6	88.0
04B-1224	24mm	43	18	32.8	26	6	96.0
04B-1225	25mm	43	18	34	28	6	105.0
04B-1226	26mm	43	18	35.2	28	6	110.0
04B-1227	27mm	43	18	36.7	29	12	125.0
04B-1228	28mm	43	18	37.7	30	12	140.0
04B-1229	29mm	43	18	39	31	12	145.0
04B-1230	30mm	43	18	40.2	31	12	150.0
04B-1232	32mm	43	18	43	31	12	180.0



WARNING!

Wear safety goggles at all time. [User and bystanders]. Do not use chrome or handtools with power wrenches. Use only impact sockets and accessories with power impact wrenches.



HAND SOCKETS & ACCESSORIES

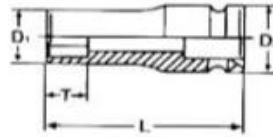

► 1/2" Drive Bi-Hexagon Deep Sockets

Stock Code	Size	L (MM)	T (MM)	D1 (MM)	D2 (MM)	Qty (Per Box) pcs	Weight (Per Pce) g
06B-1208	8mm	77	12	13.2	22	12	90.0
06B-1209	9mm	77	17	13.9	22	12	95.0
06B-1210	10mm	77	17	15	22	12	104.0
06B-1211	11mm	77	17	16.3	22	12	106.0
06B-1212	12mm	77	17	17.6	22	12	110.0
06B-1213	13mm	77	17	18.8	22	12	122.0
06B-1214	14mm	77	32	20.4	22	12	130.0
06B-1215	15mm	77	32	21	22	12	130.0
06B-1216	16mm	77	32	22	22	12	130.0
06B-1217	17mm	77	32	24	22	12	135.0
06B-1218	18mm	77	32	25.5	23	12	155.0
06B-1219	19mm	77	32	27	24	12	155.0
06B-1220	20mm	77	32	28	24	12	178.0
06B-1221	21mm	77	32	28	25	12	185.0
06B-1222	22mm	77	32	30	26	6	200.0
06B-1223	23mm	77	32	32	27	6	223.0
06B-1224	24mm	77	32	32	28	6	226.0
06B-1225	25mm	77	32	34	30	6	229.0
06B-1226	26mm	77	32	36	30	6	232.0
06B-1227	27mm	77	32	36	30	6	238.0
06B-1228	28mm	77	32	38	32	6	250.0
06B-1229	29mm	77	32	38	32	6	263.0
06B-1230	30mm	77	32	40	36	6	282.0
06B-1232	32mm	77	32	42	36	6	325.0



www.promaxusa.com



WARNING!

Wear safety goggles at all time. [User and bystanders]. Do not use chrome or handtools with power wrenches. Use only impact sockets and accessories with power impact wrenches.

HAND SOCKETS & ACCESSORIES

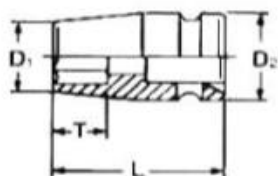

► 3/4" Drive Bi-Hexagon Regular Sockets

Stock Code	Size	L (MM)	T (MM)	D1 (MM)	D2 (MM)	Qty (Per Box) pcs	Weight (Per Pce) g
04C-1919	19mm	50	13.5	29.5	33	12	168.0
04C-1920	20mm	50	13.5	31	35	12	173.0
04C-1921	21mm	50	18	31	35	12	179.0
04C-1922	22mm	52	18	32	35	12	190.0
04C-1923	23mm	52	18	34.5	35	12	198.0
04C-1924	24mm	52	18	34.5	35	12	205.0
04C-1925	25mm	52	18	34.5	35	12	220.0
04C-1926	26mm	54	18	38.5	35	12	230.0
04C-1927	27mm	54	18	38.5	35	12	241.0
04C-1928	28mm	54	19	39.5	35	12	257.0
04C-1929	29mm	56	20	41	35	12	272.0
04C-1930	30mm	56	20	42	35	12	290.0
04C-1932	32mm	56	22	45	35	12	325.0
04C-1933	33mm	57	23	50	38	12	350.0
04C-1934	34mm	65	24	50	38	12	360.0
04C-1935	35mm	65	24	50	38	12	422.0
04C-1936	36mm	65	24	50	38	6	465.0
04C-1938	38mm	65	25	53	38	6	508.0
04C-1941	41mm	65	27	56	38	6	605.0
04C-1942	42mm	65	28	56	38	6	570.0
04C-1946	46mm	65	30	63	42	6	713.0
04C-1950	50mm	65	32	68	42	6	832.0
04C-1955	55mm	70	32	74	42	1	1,008.0
04C-1960	60mm	70	32	80	42	1	1,311.0



WARNING!

Wear safety goggles at all time. [User and bystanders]. Do not use chrome or handtools with power wrenches. Use only impact sockets and accessories with power impact wrenches.

HAND SOCKETS & ACCESSORIES

▶ 10B-1212HM/R 1/2"Drive (MM) Hexagon 12pcs



Contents : 8,10,12,13,14,17,19,21,22,24,
Ratchet, Ext Bar 125mm

Qty (per ctn) : 10 sets

Weight (per set) : 1.6kg



▶ 10B-1212PM/R 1/2"Drive (MM) Bi-Hexagon 25pcs



Contents : 8,10,12,13,14,17,19,21,22,24,
Ratchet, Ext Bar 125mm

Qty (per ctn) : 10 sets

Weight (per set) : 1.6kg



▶ 10B-1212HM/T 1/2"Drive (MM) Hexagon 12pcs



Contents : 8,10,12,13,14,17,19,21,22,24, T-Bar,
Ext Bar 125mm

Qty (per ctn) : 10 sets

Weight (per set) : 1.4kg



WARNING!

Wear safety goggles at all time. [User and bystanders]. Do not use chrome or handtools with power wrenches
Use only impact sockets and accessories with power impact wrenches

HAND SOCKETS & ACCESSORIES

▶ 10B-1212PM/T 1/2"Drive (MM) Bi-Hexagon 12pcs



Contents : 8,10,12,13,14,17,19,21,22,24, T-Bar,
Ext Bar 125mm
Qty (per ctn) : 10 sets
Weight (per set) : 1.4kg



▶ 10B-1223PMA 1/2"Drive (AF) Bi-Hexagon 23pcs



Contents : 3/8",7/16",1/2",9/16",19/32",5/8",
21/32",11/16", 3/4",25/32",
13/16",7/8",15/16",1", 1-1/16",
1-1/8",1-3/16",1-1/4" with Ratchet,
Sliding T-Handle, Extension Bar 125,
250mm, Universal Joint
Qty (per ctn) : 5 sets
Weight (per set) : 5kg



▶ 10B-1229HM 1/2"Drive (MM) Hexagon 29pcs



Contents : 17, 19 & 21mm Deep
: 10, 11, 12, 13, 14, 15, 16, 17, 18,
19, 20, 21, 22, 23, 24, 25, 26,
27, 30, 32mm with Ratchet, Sliding
T-Handle, Extension Bar 125,
250mm & Universal Joint.
Qty (per ctn) : 5 sets
Weight (per set) : 5kg



WARNING!

Wear safety goggles at all time. (User and bystanders). Do not use chrome or handtools with power wrenches
Use only impact sockets and accessories with power impact wrenches

HAND SOCKETS & ACCESSORIES

▶ 10B-1229PM 1/2"Drive (MM) Bi-Hexagon 29pcs



Contents : 17, 19, 21mm Deep
: 10, 11, 12, 13, 14, 15, 16, 17, 18,
19, 20, 21, 22, 23, 24, 25, 26,
27, 30, 32mm with Ratchet, Sliding
T-Handle, Extension Bar 125,
250mm & Universal Joint.

Qty (per ctn) : 5 sets

Weight (per set) : 5kg



▶ 10C-1920PM 3/4"Drive (MM) Bi-Hexagon 20pc



Contents : 19,21,22,23,24,26,27,29,30,32,35,
36,38,41,46,50mm with Ratchet,
Sliding T-Handle, Extension Bar 100,
200mm

Qty (per ctn) : 1 set

Weight (per set) : 13kg



WARNING!

Wear safety goggles at all time (User and bystanders). Do not use chrome or handtools with power wrenches.
Use only impact sockets and accessories with power impact wrenches

HAND SOCKETS & ACCESSORIES

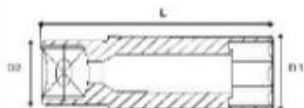

▶ Hexagon Spark Plug (With Rubber)

Stock Code	Sq. Dr	Size	L (MM)	T (MM)	D1 (MM)	D2 (MM)	Qty (Per Box) pcs	Weight (Per Pce) g
SP-1221	1/2"	21mm	65	23	28	24	12	198.0

▶ Extension Bar

Stock Code	Sq. Dr	L (MM)	Qty (Per Box) pcs	Weight (Per Pce) g
37B-12075	1/2"	75	12	125.0
37B-12125	1/2"	125	12	190.0
37B-12250	1/2"	250	12	325.0
37C-19100	3/4"	100	12	330.0
37C-19200	3/4"	200	6	590.0
37C-19400	3/4"	400	3	1,080.0

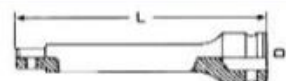

▶ Universal Joint

Stock Code	Sq. Dr	L (MM)	Qty (Per Box) pcs	Weight (Per Pce) g
38B-12075	1/2"	75	6	140.0
38C-19105	3/4"	100	6	460.0



WARNING!

Wear safety goggles at all time. [User and bystanders]. Do not use chrome or handtools with power wrenches. Use only impact sockets and accessories with power impact wrenches.

HAND SOCKETS & ACCESSORIES

▶ Sliding T-Handle

Stock Code	Sq. Dr	L (MM)	Qty (Per Box) pcs	Weight (Per Pce) g
39B-12250	1/2"	250	6	400.0
39B-12305	1/2"	300	6	445.0
39C-19450	3/4"	450	6	1,460.0

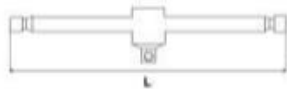

▶ Ratchet Handle

Stock Code	Sq. Dr	L (MM)	Qty (Per Box) pcs	Weight (Per Pce) g
40A-1072	3/8"	195	6	310.0
40B-1200-36T	1/2"	250	6	505.0
40C-RA19500	3/4"	500	12	1,908.0



▶ L-Handle

Stock Code	Sq. Dr	L (MM)	Qty (Per Box) pcs	Weight (Per Pce) g
41B-12190	1/2"	250	12	220.0
41C-19330	3/4"	330	6	1,175.0



▶ Tyre Lever

Stock Code	L (MM)	Qty (Per Box) pcs	Weight (Per Pce) g
TL0300	300	12	300



WARNING!

Wear safety goggles at all time. [User and bystanders]. Do not use chrome or handtools with power wrenches
Use only impact sockets and accessories with power impact wrenches



**IMPACT
SOCKETS
AND
ACCESSORIES**



IMPACT SOCKETS

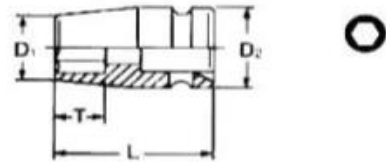

▶ 3/8" Dr Hexagon Regular Sockets

Stock Code	Size	L (MM)	T (MM)	D1 (MM)	D2 (MM)	Qty (Per Box) pcs	Weight (Per Pce) g
NA-1006	6mm	30	4.0	10.5	19.0	12	20.0
NA-1007	7mm	30	8.0	11.5	19.0	12	22.0
NA-1008	8mm	30	8.0	12.5	19.0	12	24.0
NA-1009	9mm	30	8.0	14.0	19.0	12	27.0
NA-1010	10mm	30	8.0	15.0	19.0	12	30.0
NA-1011	11mm	30	9.0	17.0	19.0	12	35.0
NA-1012	12mm	30	9.0	18.0	19.0	12	40.0
NA-1013	13mm	30	9.0	19.0	19.0	12	44.0
NA-1014	14mm	30	9.0	20.0	20.0	12	48.0
NA-1015	15mm	30	11.0	22.0	22.0	12	52.0
NA-1016	16mm	30	11.0	24.0	22.0	12	57.0
NA-1017	17mm	30	11.0	25.0	22.0	12	60.0
NA-1019	19mm	30	11.0	27.5	22.0	12	68.0
NA-1020	20mm	30	12.0	28.0	22.0	6	71.0
NA-1021	21mm	30	13.0	30.0	22.0	6	75.0
NA-1022	22mm	30	13.0	32.0	23.0	6	76.0
NA-1024	24mm	30	13.0	34.0	23.0	6	80.0
OA-1006	1/4"	30	4.0	11.0	19.0	12	22.0
OA-1008	5/16"	30	8.0	12.5	19.0	12	27.0
OA-1010	3/8"	30	8.0	14.5	19.0	12	33.0
OA-1011	7/16"	30	9.0	17.0	19.0	12	36.0
OA-1013	1/2"	30	9.0	19.0	19.0	12	46.0
OA-1014	9/16"	30	9.0	20.0	20.0	12	50.0
OA-1016	5/8"	30	11.0	24.0	24.0	12	59.0
OA-1017	11/16"	30	11.0	24.0	24.0	12	63.0
OA-1019	3/4"	30	11.0	26.0	26.0	12	70.0
OA-1020	13/16"	30	13.0	28.0	28.0	6	72.0
OA-1022	7/8"	30	13.0	30.0	30.0	6	77.0
OA-1024	15/16"	30	13.0	32.0	32.0	6	82.0
OA-1025	1"	30	13.0	34.0	34.0	6	86.0



www.promaxusa.com



WARNING!

Wear safety goggles at all time. (User and bystanders). Do not use chrome or handtools with power wrenches. Use only impact sockets and accessories with power impact wrenches.

IMPACT SOCKETS

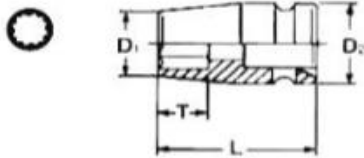

► 3/8" Dr Bi-Hexagon Regular Sockets

Stock Code	Size	L (MM)	T (MM)	D1 (MM)	D2 (MM)	Qty (Per Box) pcs	Weight (Per Pce) g
TNA-1006	6mm	30	4.0	10.5	19.0	12	19.0
TNA-1007	7mm	30	8.0	11.5	19.0	12	21.0
TNA-1008	8mm	30	8.0	12.5	19.0	12	23.0
TNA-1009	9mm	30	8.0	14.0	19.0	12	26.0
TNA-1010	10mm	30	8.0	16.0	19.0	12	28.0
TNA-1011	11mm	30	9.0	17.0	19.0	12	34.0
TNA-1012	12mm	30	9.0	19.0	19.0	12	38.0
TNA-1013	13mm	30	9.0	19.0	22.0	12	43.0
TNA-1014	14mm	30	9.0	20.0	22.0	12	47.0
TNA-1015	15mm	30	11.0	22.0	22.0	12	51.0
TNA-1016	16mm	30	11.0	24.0	22.0	12	56.0
TNA-1017	17mm	30	11.0	25.0	22.0	12	58.0
TNA-1019	19mm	30	13.0	27.5	22.0	12	67.0
TNA-1020	20mm	30	13.0	28.0	22.0	6	70.0
TNA-1021	21mm	30	13.0	30.0	22.0	6	74.0
TNA-1022	22mm	30	15.0	32.0	23.0	6	75.0
TNA-1024	24mm	30	16.0	34.0	23.0	6	78.0
TOA-1006	1/4"	30	4.0	11.0	19.0	12	21.0
TOA-1008	5/16"	30	8.0	12.5	19.0	12	26.0
TOA-1010	3/8"	30	8.0	14.5	19.0	12	32.0
TOA-1011	7/16"	30	9.0	17.0	19.0	12	35.0
TOA-1013	1/2"	30	9.0	19.0	19.0	12	45.0
TOA-1014	9/16"	30	11.0	20.0	22.0	12	49.0
TOA-1016	5/8"	30	12.0	24.0	22.0	12	58.0
TOA-1017	11/16"	30	12.0	24.0	22.0	12	62.0
TOA-1019	3/4"	30	13.0	26.0	22.0	12	69.0
TOA-1020	13/16"	30	14.0	28.0	22.0	6	71.0
TOA-1022	7/8"	30	15.0	30.0	23.0	6	76.0
TOA-1024	15/16"	30	16.0	32.0	23.0	6	81.0
TOA-1025	1"	30	16.0	34.0	23.0	6	85.0



WARNING!

Wear safety goggles at all time. [User and bystanders]. Do not use chrome or handtools with power wrenches. Use only impact sockets and accessories with power impact wrenches.



IMPACT SOCKETS

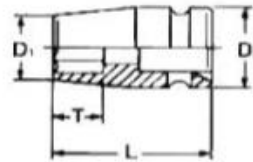

► 1/2" Dr Hexagon Regular Sockets

Stock Code	Size	L (MM)	T (MM)	D1 (MM)	D2 (MM)	Qty (Per Box) pcs	Weight (Per Pce) g
NB-1208	8mm	39	9	15	25	12	70.0
NB-1209	9mm	39	12	16	25	12	72.0
NB-1210	10mm	39	12	17.5	25	12	76.0
NB-1211	11mm	39	12	18.7	25	12	78.0
NB-1212	12mm	39	12	20	25	12	80.0
NB-1213	13mm	39	12	21	25	12	82.0
NB-1214	14mm	39	12	22.5	25	12	85.0
NB-1215	15mm	39	12	23.5	25	12	86.0
NB-1216	16mm	39	12	25	25	12	88.0
NB-1217	17mm	39	13	26	26	12	90.0
NB-1218	18mm	39	13	27.5	26	12	95.0
NB-1219	19mm	39	13	28.5	28	12	110.0
NB-1220	20mm	39	13	30	30	6	125.0
NB-1221	21mm	39	13	30	30	6	128.0
NB-1222	22mm	39	13	32	30	6	130.0
NB-1223	23mm	39	13	32	30	6	140.0
NB-1224	24mm	46	20	35	30	6	170.0
NB-1225	25mm	46	20	36	30	6	180.0
NB-1226	26mm	51	22	38	30	12	220.0
NB-1227	27mm	51	22	38.5	30	12	230.0
NB-1228	28mm	51	22	40	30	12	240.0
NB-1229	29mm	51	22	40	30	12	243.0
NB-1230	30mm	51	22	42	30	12	250.0
NB-1231	31mm	51	28	44	30	12	255.0
NB-1232	32mm	51	28	44	30	12	260.0
NB-1233	33mm	51	28	44	30	12	265.0
NB-1235	35mm	51	28	44	30	12	272.0
NB-1236	36mm	51	28	49	30	12	280.0



www.promaxusa.com



WARNING!

Wear safety goggles at all time. [User and bystanders]. Do not use chrome or handtools with power wrenches. Use only impact sockets and accessories with power impact wrenches.

► 1/2"Dr Hexagon Regular Sockets

Stock Code	Size	L (MM)	T (MM)	D1 (MM)	D2 (MM)	Qty (Per Box) pcs	Weight (Per Pce) g
OB-1208	5/16"	39	9	15	22	12	60.0
OB-1210	3/8"	39	12	16	22	12	63.0
OB-1211	7/16"	39	12	18	22	12	70.0
OB-1213	1/2"	39	12	20	22	12	75.0
OB-1214	9/16"	39	12	22	24	12	80.0
OB-1216	5/8"	39	12	25	25	12	84.0
OB-1217	11/16"	39	13	26	26	12	90.0
OB-1219	3/4"	39	13	28	28	12	110.0
OB-1220	13/16"	39	13	30	30	6	120.0
OB-1222	7/8"	39	13	32	32	6	150.0
OB-1224	15/16"	39	13	34	34	6	160.0
OB-1225	1"	39	13	36	36	6	180.0
OB-1227	1-1/16"	39	14	38	38	12	210.0
OB-1229	1-1/8"	39	16	40	38	12	230.0
OB-1230	1-3/16"	41	16	42	38	12	240.0
OB-1231	1-1/4"	41	18	44	38	12	250.0
OB-1233	1-5/16"	45	21	45	38	12	260.0
OB-1235	1-3/8"	50	26	48.5	38	12	270.0
OB-1236	1-7/16"	50	26	50.5	38	12	370.0
OB-1238	1-1/2"	50	26	52.5	38	12	380.0

► 1/2"Dr Bi-Hexagon Regular Sockets

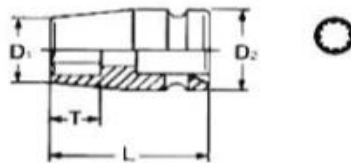

Stock Code	Size	L (MM)	T (MM)	D1 (MM)	D2 (MM)	Qty (Per Box) pcs	Weight (Per Pce) g
TNB-1208	8mm	38	9	15	24	12	53.0
TNB-1209	9mm	38	12	15	24	12	57.0
TNB-1210	10mm	38	12	17	24	12	60.0
TNB-1211	11mm	38	12	18	24	12	62.0
TNB-1212	12mm	38	12	19	24	12	65.0
TNB-1213	13mm	38	12	20	24	12	68.0
TNB-1214	14mm	38	12	22	24	12	70.0



WARNING!

Wear safety goggles at all time. [User and bystanders]. Do not use chrome or handtools with power wrenches. Use only impact sockets and accessories with power impact wrenches.

► 1/2" Dr Bi-Hexagon Regular Sockets

Stock Code	Size	L (MM)	T (MM)	D1 (MM)	D2 (MM)	Qty (Per Box) pcs	Weight (Per Pce) g
TNB-1215	15mm	38	12	24	24	12	90.0
TNB-1216	16mm	38	12	24	24	12	110.0
TNB-1217	17mm	38	13	26	26	12	120.0
TNB-1218	18mm	38	13	26	26	12	110.0
TNB-1219	19mm	38	13	28	28	12	100.0
TNB-1220	20mm	38	13	30	30	6	102.0
TNB-1221	21mm	38	13	30	30	6	105.0
TNB-1222	22mm	38	13	32	32	6	120.0
TNB-1223	23mm	38	13	32	32	6	125.0
TNB-1224	24mm	45	19	34	34	6	180.0
TNB-1225	25mm	45	19	36	36	6	185.0
TNB-1226	26mm	50	20	36	36	12	190.0
TNB-1227	27mm	50	20	38	38	12	240.0
TNB-1228	28mm	50	20	40	38	12	238.0
TNB-1229	29mm	50	20	40	38	12	234.0
TNB-1230	30mm	50	20	42	38	12	230.0
TNB-1231	31mm	50	20	44	38	12	240.0
TNB-1232	32mm	50	20	44	38	12	250.0
TNB-1233	33mm	50	25	45	38	12	245.0
TNB-1234	34mm	50	25	48	38	12	238.0
TNB-1235	35mm	50	25	48	38	12	232.0
TNB-1236	36mm	50	25	48	38	12	226.0
TOB-1208	5/16"	38	9	15	25	12	58.0
TOB-1210	3/8"	38	12	17	25	12	61.0
TOB-1211	7/16"	38	12	19	25	12	68.0
TOB-1213	1/2"	38	12	21	25	12	73.0
TOB-1214	9/16"	38	12	22.5	25	12	78.0
TOB-1216	5/8"	38	12	25	25	12	82.0
TOB-1217	11/16"	38	13	27	26	12	88.0
TOB-1219	3/4"	38	13	29	28	12	108.0
TOB-1220	13/16"	38	13	31	30	6	118.0
TOB-1222	7/8"	38	13	32.5	32	6	148.0
TOB-1224	15/16"	45	19	35	35	6	158.0
TOB-1225	1"	45	19	37	37	6	178.0
TOB-1227	1-1/16"	50	20	39	39	12	208.0
TOB-1229	1-1/8"	50	20	41	38	12	228.0
TOB-1230	1-3/16"	50	20	42.5	38	12	238.0
TOB-1231	1-1/4"	50	20	45	38	12	248.0
TOB-1233	1-5/16"	50	25	46.5	38	12	258.0
TOB-1235	1-3/8"	50	26	47	38	12	268.0
TOB-1236	1-7/16"	50	26	48.5	38	12	368.0
TOB-1238	1-1/2"	50	26	50.5	38	6	378.0



WARNING!

Wear safety goggles at all time. [User and bystanders]. Do not use chrome or handtools with power wrenches. Use only impact sockets and accessories with power impact wrenches.

IMPACT SOCKETS

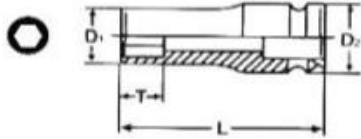

► 1/2" Dr Hexagon Deep Sockets

Stock Code	Size	L (MM)	T (MM)	D1 (MM)	D2 (MM)	Qty (Per Box) pcs	Weight (Per Pce) g
QB-1208	8mm	79	13	15	25	6	131.0
QB-1209	9mm	79	14	16	25	6	135.0
QB-1210	10mm	79	14	17.5	25	6	140.0
QB-1211	11mm	79	14	18.5	25	6	150.0
QB-1212	12mm	79	14	20	25	6	160.0
QB-1213	13mm	79	14	21	25	6	165.0
QB-1214	14mm	79	17	22.5	25	6	170.0
QB-1215	15mm	79	17	23.7	30	12	225.0
QB-1216	16mm	79	17	25	30	12	230.0
QB-1217	17mm	79	17	26	30	12	235.0
QB-1218	18mm	79	17	27.5	30	12	250.0
QB-1219	19mm	79	19	28.5	30	12	260.0
QB-1220	20mm	79	19	30	30	12	270.0
QB-1221	21mm	79	24	30	30	12	280.0
QB-1222	22mm	79	24	32	30	6	290.0
QB-1223	23mm	79	24	32	30	6	270.0
QB-1224	24mm	79	24	35	30	6	330.0
QB-1225	25mm	79	24	36	30	6	340.0
QB-1226	26mm	79	24	38	30	6	380.0
QB-1227	27mm	79	54	38.5	30	6	390.0
QB-1228	28mm	79	54	40	30	6	400.0
QB-1229	29mm	79	54	40	30	6	410.0
QB-1230	30mm	79	54	42	30	6	430.0
QB-1231	31mm	79	54	43	30	6	440.0
QB-1232	32mm	79	54	44	30	6	450.0
QB-1233	33mm	79	54	45	30	6	500.0
QB-1235	35mm	79	54	47	30	6	530.0
QB-1236	36mm	79	54	49	30	6	570.0
RB-1208	5/16"	78	13	15	22	6	107.0
RB-1210	3/8"	78	14	16	22	6	110.0
RB-1211	7/16"	78	14	18	22	6	120.0



WARNING!

Wear safety goggles at all time. [User and bystanders]. Do not use chrome or handtools with power wrenches. Use only impact sockets and accessories with power impact wrenches.

IMPACT SOCKETS

► 1/2" Dr Hexagon Deep Sockets

Stock Code	Size	L (MM)	T (MM)	D1 (MM)	D2 (MM)	Qty (Per Box) pcs	Weight (Per Pce) g
RB-1213	1/2"	78	14	20	22	6	130.0
RB-1214	9/16"	78	17	22	24	6	160.0
RB-1216	5/8"	78	17	24	24	12	180.0
RB-1217	11/16"	78	17	26	26	12	200.0
RB-1219	3/4"	78	19	28	28	12	220.0
RB-1220	13/16"	78	24	30	30	12	250.0
RB-1222	7/8"	78	24	32	32	6	280.0
RB-1224	15/16"	78	24	34	34	6	320.0
RB-1225	1"	78	24	36	36	6	360.0
RB-1227	1-1/16"	78	24	38	38	6	400.0
RB-1229	1-1/8"	78	54	40	38	6	430.0
RB-1230	1-3/16"	78	54	42	38	6	420.0
RB-1231	1-1/4"	78	54	44	38	6	410.0
RB-1233	1-5/16"	78	54	45	38	6	460.0
RB-1235	1-3/8"	78	54	48.5	38	6	500.0
RB-1236	1-7/16"	78	54	50.5	38	6	540.0
RB-1238	1-1/2"	78	54	52.5	38	6	620.0

► 1/2" Dr Bi-Hexagon Deep Sockets

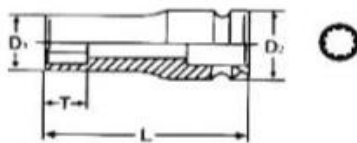

Stock Code	Size	L (MM)	T (MM)	D1 (MM)	D2 (MM)	Qty (Per Box) pcs	Weight (Per Pce) g
QB1-1208	8mm	83	13	15	25	16	129.0
QB1-1209	9mm	83	14	16	25	16	133.0
QB1-1210	10mm	83	14	17.5	25	6	138.0
QB1-1211	11mm	83	14	19	25	6	148.0
QB1-1212	12mm	83	14	20	25	6	158.0
QB1-1213	13mm	83	14	21	25	6	163.0
QB1-1214	14mm	83	24	22.5	25	6	168.0



WARNING!

Wear safety goggles at all time. [User and bystanders]. Do not use chrome or handtools with power wrenches. Use only impact sockets and accessories with power impact wrenches.

IMPACT SOCKETS

▶ 1/2" Dr Bi-Hexagon Deep Sockets

Stock Code	Size	L (MM)	T (MM)	D1 (MM)	D2 (MM)	Qty (Per Box) pcs	Weight (Per Pce) g
QB1-1215	15mm	83	24	23.5	30	12	223.0
QB1-1216	16mm	83	24	25	30	12	228.0
QB1-1217	17mm	83	24	26.5	30	12	230.0
QB1-1218	18mm	83	24	27.5	30	12	248.0
QB1-1219	19mm	83	24	29	30	12	250.0
QB1-1220	20mm	83	24	30	30	12	268.0
QB1-1221	21mm	83	24	31	30	12	280.0
QB1-1222	22mm	90	24	32.5	30	6	288.0
QB1-1223	23mm	90	24	34	30	6	268.0
QB1-1224	24mm	90	24	35	30	6	328.0
QB1-1225	25mm	90	24	36	30	6	347.0
QB1-1226	26mm	90	24	38	30	6	378.0
QB1-1227	27mm	90	24	39	30	6	388.0
QB1-1228	28mm	90	24	40	30	6	398.0
QB1-1229	29mm	90	24	41	30	6	408.0
QB1-1230	30mm	90	24	42.5	30	6	428.0
QB1-1231	31mm	90	24	44	30	6	438.0
QB1-1232	32mm	90	24	45	30	6	448.0
QB1-1233	33mm	90	35	46.5	30	6	498.0
QB1-1234	34mm	90	36	48	30	6	510.0
QB1-1235	35mm	90	37	50	30	6	528.0
QB1-1236	36mm	90	38	52	30	6	568.0
RB1-1206	1/4"	83	6	13	25	6	100.0
RB1-1208	5/16"	83	13	15	25	6	105.0
RB1-1210	3/8"	83	14	17	25	6	108.0
RB1-1211	7/16"	83	14	19	25	6	118.0
RB1-1213	1/2"	83	14	21	25	6	128.0
RB1-1214	9/16"	83	24	22.5	25	6	158.0
RB1-1216	5/8"	83	24	25	28	12	178.0
RB1-1217	11/16"	83	24	27	30	12	198.0
RB1-1219	3/4"	83	24	29	30	12	218.0
RB1-1220	13/16"	83	24	31	30	12	248.0
RB1-1222	7/8"	90	24	32.5	30	6	278.0
RB1-1224	15/16"	90	24	35	30	6	318.0
RB1-1225	1"	90	24	37	30	6	358.0
RB1-1227	1-1/16"	90	24	39	30	6	398.0
RB1-1229	1-1/8"	90	24	41	30	6	428.0
RB1-1230	1-3/16"	90	24	42.5	30	6	418.0



WARNING!

Wear safety goggles at all time. [User and bystanders]. Do not use chrome or handtools with power wrenches. Use only impact sockets and accessories with power impact wrenches.

IMPACT SOCKETS

▶ 1/2"Dr Bi-Hexagon Deep Sockets

Stock Code	Size	L (MM)	T (MM)	D1 (MM)	D2 (MM)	Qty (Per Box) pcs	Weight (Per Pce) g
RB1-1231	1-1/4"	90	24	45	30	6	408.0
RB1-1233	1-5/16"	90	35	46.5	30	6	458.0
RB1-1235	1-3/8"	90	37	49.5	30	6	498.0
RB1-1236	1-7/16"	90	39	51	30	6	538.0
RB1-1238	1-1/2"	90	40	53	38	6	618.0

▶ 1/2"Dr Torx Thin Walled Regular Sockets

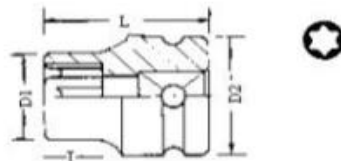

Stock Code	Size	L (MM)	T (MM)	D1 (MM)	D2 (MM)	Qty (Per Box) pcs	Weight (Per Pce) g
TXE-1210	E10	38	7.5	13	25.0	12	60.0
TXE-1211	E11	38	8	14	25.0	12	65.0
TXE-1212	E12	38	8.5	15	25.0	12	67.0
TXE-1214	E14	38	10	17	25.0	12	70.0
TXE-1216	E16	38	11	18.5	25.0	12	75.0
TXE-1218	E18	38	12	20.5	25.0	12	80.0
TXE-1220	E20	38	13.5	22.5	30.0	6	120.0
TXE-1222	E22	45	18	24.5	30.0	6	140.0
TXE-1224	E24	45	18	26.5	30.0	6	150.0



WARNING!

Wear safety goggles at all time. [User and bystanders]. Do not use chrome or handtools with power wrenches
Use only impact sockets and accessories with power impact wrenches

IMPACT SOCKETS

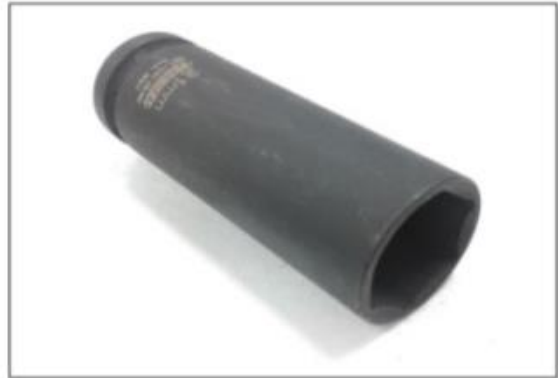
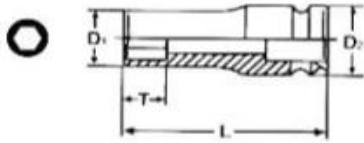

► 1/2" Dr Hexagon Thin Walled Deep Sockets

Stock Code	Size	L (MM)	T (MM)	D1 (MM)	D2 (MM)	Qty (Per Box) pcs	Weight (Per Pce) g
QBT-1208	8mm	79	13	14	22	12	80.0
QBT-1209	9mm	79	14	14.5	22	12	85.0
QBT-1210	10mm	79	14	15.5	22	12	90.0
QBT-1211	11mm	79	14	16.7	22	12	95.0
QBT-1212	12mm	79	14	18	22	12	110.0
QBT-1213	13mm	79	14	19.2	24	12	125.0
QBT-1214	14mm	79	17	21	24	12	140.0
QBT-1215	15mm	79	17	21.7	24	12	150.0
QBT-1216	16mm	79	17	23	24	12	160.0
QBT-1217	17mm	79	17	24	24	12	170.0
QBT-1218	18mm	79	17	25	25	12	180.0
QBT-1219	19mm	79	19	26	26	12	190.0
QBT-1220	20mm	79	19	27.5	27.5	12	195.0
QBT-1221	21mm	79	24	28	28	12	200.0
QBT-1222	22mm	79	24	29.5	29.5	6	210.0
QBT-1223	23mm	79	24	30.5	30.5	6	220.0
QBT-1224	24mm	79	24	32	32	6	250.0
QBT-1225	25mm	79	24	33	33	6	290.0
QBT-1226	26mm	79	24	35	35	6	330.0
QBT-1227	27mm	79	24	36	36	6	340.0
QBT-1228	28mm	79	24	37.5	37.5	6	350.0
QBT-1229	29mm	79	54	38.5	38	6	360.0
QBT-1230	30mm	79	54	40	38	6	380.0
QBT-1231	31mm	79	54	41	38	6	390.0
QBT-1232	32mm	79	54	42	38	6	400.0



WARNING!

Wear safety goggles at all time. [User and bystanders]. Do not use chrome or handtools with power wrenches
Use only impact sockets and accessories with power impact wrenches



IMPACT SOCKETS

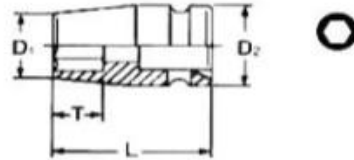

► 3/4" Dr Hexagon Regular Sockets

Stock Code	Size	L (MM)	T (MM)	D1 (MM)	D2 (MM)	Qty (Per Box) pcs	Weight (Per Pce) g
NC-1913	13mm	51	12	22	38	12	185.0
NC-1914	14mm	51	12	25.5	38	12	190.0
NC-1915	15mm	51	12	26	38	12	194.0
NC-1916	16mm	51	12	27	38	12	220.0
NC-1917	17mm	51	12	29	38	12	224.0
NC-1918	18mm	51	12	30	38	12	227.0
NC-1919	19mm	51	14	30	38	12	235.0
NC-1920	20mm	53	16	31	38	12	240.0
NC-1921	21mm	53	16	32	38	12	250.0
NC-1922	22mm	53	16	34	38	12	260.0
NC-1923	23mm	53	16	35	38	12	265.0
NC-1924	24mm	53	16	36	38	12	270.0
NC-1925	25mm	53	16	38	38	12	275.0
NC-1926	26mm	53	16	40	38	12	280.0
NC-1927	27mm	53	16	40	38	12	285.0
NC-1928	28mm	53	21	42	42	12	290.0
NC-1929	29mm	53	21	42	42	12	310.0
NC-1930	30mm	53	21	44	44	12	360.0
NC-1931	31mm	53	21	44	44	12	365.0
NC-1932	32mm	53	21	44	44	12	373.0
NC-1933	33mm	57	23	47	44	12	410.0
NC-1934	34mm	57	23	48	44	12	420.0
NC-1935	35mm	57	23	50	44	12	450.0
NC-1936	36mm	57	23	51	44	6	460.0
NC-1937	37mm	57	24	51	44	6	463.0
NC-1938	38mm	57	24	53	44	6	470.0
NC-1939	39mm	63	28	56	44	6	575.0
NC-1940	40mm	63	28	56	44	6	580.0
NC-1941	41mm	63	28	58	44	6	600.0
NC-1942	42mm	63	28	61	44	6	675.0
NC-1943	43mm	64	27	63	44	6	740.0



www.promaxusa.com



WARNING!

Wear safety goggles at all time. [User and bystanders]. Do not use chrome or handtools with power wrenches. Use only impact sockets and accessories with power impact wrenches.

IMPACT SOCKETS

▶ 3/4" Dr Hexagon Regular Sockets

Stock Code	Size	L (MM)	T (MM)	D1 (MM)	D2 (MM)	Qty (Per Box) pcs	Weight (Per Pce) g
NC-1944	44mm	64	27	65	44	6	772.0
NC-1945	45mm	64	27	66	44	6	795.0
NC-1946	46mm	64	27	67	44	6	820.0
NC-1947	47mm	69	32	68	44	6	870.0
NC-1948	48mm	69	32	69	44	6	890.0
NC-1949	49mm	69	34	70	44	6	960.0
NC-1950	50mm	73	35	71	54	6	1,105.0
NC-1952	52mm	73	35	74	54	6	1,220.0
NC-1953	53mm	73	35	75	54	6	1,250.0
NC-1954	54mm	73	35	77	54	6	1,265.0
NC-1955	55mm	75	35	77	54	1	1,290.0
NC-1956	56mm	75	35	80	54	1	1,390.0
NC-1958	58mm	75	35	82	54	1	1,410.0
NC-1960	60mm	75	35	84	54	1	1,480.0
NC-1963	63mm	75	35	86	54	1	1,505.0
NC-1965	65mm	79	38	88	54	1	1,550.0
NC-1967	67mm	81	40	90	54	1	1,620.0
OC-1913	1/2"	51	12	22	38	12	208.0
OC-1914	9/16"	51	12	25.5	38	12	219.0
OC-1916	5/8"	51	12	27.5	38	12	224.0
OC-1917	11/16"	51	12	29	38	12	230.0
OC-1919	3/4"	51	14	30	38	12	240.0
OC-1920	13/16"	53	16	32	38	12	250.0
OC-1922	7/8"	53	16	34	38	12	258.0
OC-1924	15/16"	53	16	36	38	12	265.0
OC-1925	1"	53	16	40	38	12	280.0
OC-1927	1-1/16"	53	16	40	38	12	290.0
OC-1929	1-1/8"	53	20	42	42	12	310.0
OC-1930	1-3/16"	53	20	44	44	12	360.0
OC-1931	1-1/4"	53	20	44	44	12	365.0
OC-1933	1-5/16"	57	23	47	44	12	400.0
OC-1935	1-3/8"	57	23	50	44	6	450.0
OC-1936	1-7/16"	57	23	51	44	6	453.0
OC-1938	1-1/2"	57	23	53	44	6	458.0
OC-1940	1-9/16"	63	27	56	44	6	570.0
OC-1941	1-5/8"	63	27	58	44	6	650.0
OC-1943	1-11/16"	63	27	63.5	44	6	720.0
OC-1944	1-3/4"	63	27	65	44	6	760.0



WARNING!

Wear safety goggles at all time. [User and bystanders]. Do not use chrome or handtools with power wrenches. Use only impact sockets and accessories with power impact wrenches.

IMPACT SOCKETS

▶ 3/4"Dr Hexagon Regular Sockets

Stock Code	Size	L (MM)	T (MM)	D1 (MM)	D2 (MM)	Qty (Per Box) pcs	Weight (Per Pce) g
OC-1946	1-13/16"	69	32	67	44	6	880.0
OC-1948	1-7/8"	69	32	68	44	6	885.0
OC-1949	1-15/16"	71	34	71	44	6	940.0
OC-1951	2"	73	35	73	54	6	1,100.0
OC-1952	2-1/16"	73	35	74	54	6	1,220.0
OC-1954	2-1/8"	73	35	77	54	1	1,227.0
OC-1956	2-3/16"	75	35	77	54	1	1,260.0
OC-1957	2-1/4"	75	35	80	54	1	1,380.0
OC-1959	2-5/16"	76	35	82	54	1	1,400.0
OC-1960	2-3/8"	76	35	84	54	1	1,460.0
OC-1961	2-7/16"	76	35	85	54	1	1,510.0
OC-1963	2-1/2"	76	35	86	54	1	1,540.0

▶ 3/4"Dr Bi-Hexagon Regular Sockets

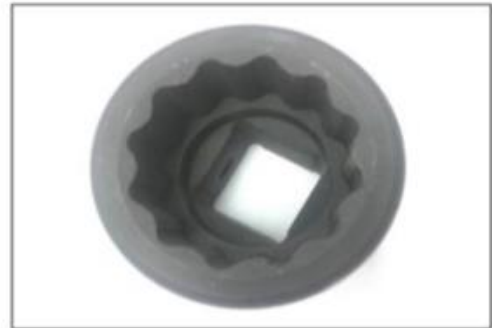
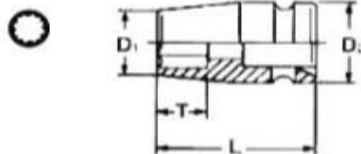

Stock Code	Size	L (MM)	T (MM)	D1 (MM)	D2 (MM)	Qty (Per Box) pcs	Weight (Per Pce) g
TNC-1913	13mm	50	12	23	38	12	270.0
TNC-1914	14mm	50	12	24	38	12	285.0
TNC-1915	15mm	50	12	26	38	12	294.0
TNC-1916	16mm	50	12	27	38	12	325.0
TNC-1917	17mm	50	12	28	38	12	340.0
TNC-1918	18mm	50	12	29	38	12	343.0
TNC-1919	19mm	50	14	30	38	12	350.0
TNC-1920	20mm	52	16	31	38	12	357.0
TNC-1921	21mm	52	16	32	38	12	360.0
TNC-1922	22mm	52	16	34	38	12	370.0
TNC-1923	23mm	52	16	35	38	12	375.0



www.promaxusa.com



WARNING!

Wear safety goggles at all time. [User and bystanders]. Do not use chrome or handtools with power wrenches. Use only impact sockets and accessories with power impact wrenches.

IMPACT SOCKETS

▶ 3/4" Dr Bi-Hexagon Regular Sockets

Stock Code	Size	L (MM)	T (MM)	D1 (MM)	D2 (MM)	Qty (Per Box) pcs	Weight (Per Pce) g
TNC-1924	24mm	53	18	36	38	12	378.0
TNC-1925	25mm	53	18	38	38	12	380.0
TNC-1926	26mm	53	23	40	38	12	383.0
TNC-1927	27mm	53	23	40	38	12	385.0
TNC-1928	28mm	53	23	43	38	12	390.0
TNC-1929	29mm	53	23	43	38	12	400.0
TNC-1930	30mm	53	23	43	38	12	430.0
TNC-1931	31mm	56	24	44	38	12	447.0
TNC-1932	32mm	56	24	45	38	12	460.0
TNC-1933	33mm	56	24	46	38	12	490.0
TNC-1934	34mm	56	24	49	38	6	498.0
TNC-1935	35mm	56	24	51	38	6	505.0
TNC-1936	36mm	56	24	51	38	6	512.0
TNC-1937	37mm	56	24	52	38	6	525.0
TNC-1938	38mm	56	24	53	38	6	560.0
TNC-1939	39mm	62	28	55	38	6	592.0
TNC-1940	40mm	62	28	57	38	6	598.0
TNC-1941	41mm	62	28	58	38	6	610.0
TNC-1942	42mm	62	28	61	38	6	640.0
TNC-1943	43mm	62	28	63	38	6	670.0
TNC-1944	44mm	63	28	64	38	6	700.0
TNC-1945	45mm	63	28	66	38	6	730.0
TNC-1946	46mm	68	33	67	38	6	770.0
TNC-1947	47mm	68	33	68	38	6	835.0
TNC-1948	48mm	68	33	69	38	1	900.0
TNC-1950	50mm	70	34	71	38	1	965.0
TNC-1951	51mm	72	34	72	54	1	1,030.0
TNC-1952	52mm	72	34	74	54	1	1,095.0
TNC-1953	53mm	72	34	75	54	1	1,160.0
TNC-1954	54mm	72	34	77	54	1	1,225.0
TNC-1955	55mm	74	35	77	54	1	1,290.0
TNC-1956	56mm	74	35	77	54	1	1,325.0
TNC-1957	57mm	74	35	80	54	1	1,360.0
TNC-1958	58mm	75	35	81	54	1	1,400.0
TNC-1960	60mm	75	35	84	54	1	1,440.0
TNC-1963	63mm	78	37	86	54	1	1,515.0
TNC-1965	65mm	78	38	88	54	1	1,558.0
TNC-1967	67mm	80	40	90	54	1	1,635.0



WARNING!

Wear safety goggles at all time. [User and bystanders]. Do not use chrome or handtools with power wrenches. Use only impact sockets and accessories with power impact wrenches.

IMPACT SOCKETS

► 3/4" Dr Bi-Hexagon Regular Sockets

Stock Code	Size	L (MM)	T (MM)	D1 (MM)	D2 (MM)	Qty (Per Box) pcs	Weight (Per Pce) g
TOC-1912	1/2"	50	9	24.5	44	12	313.0
TOC-1914	9/16"	50	11	25.5	44	12	324.0
TOC-1916	5/8"	50	11	28	44	12	329.0
TOC-1917	11/16"	50	12	31.5	44	12	335.0
TOC-1919	3/4"	50	13	33	44	12	345.0
TOC-1920	13/16"	50	15	35	44	12	355.0
TOC-1922	7/8"	50	15	37	44	12	363.0
TOC-1924	15/16"	50	18	39	44	12	370.0
TOC-1925	1"	50	18	41	44	12	385.0
TOC-1927	1-1/16"	54	19	43	44	12	395.0
TOC-1929	1-1/8"	54	21	44.5	44	12	415.0
TOC-1930	1-3/16"	54	21	47	44	12	465.0
TOC-1931	1-1/4"	56	22	49	44	12	470.0
TOC-1933	1-5/16"	56	22	51	44	12	505.0
TOC-1935	1-3/8"	56	22	53	44	6	555.0
TOC-1936	1-7/16"	56	25	55	44	6	558.0
TOC-1938	1-1/2"	58	25	57	44	6	563.0
TOC-1940	1-9/16"	58	25	59	44	6	675.0
TOC-1941	1-5/8"	58	27	61	44	6	755.0
TOC-1943	1-11/16"	63	27	63.5	44	6	825.0
TOC-1944	1-3/4"	63	27	64.5	44	6	865.0
TOC-1946	1-13/16"	63	30	67	44	6	985.0
TOC-1948	1-7/8"	68	30	68	44	1	990.0
TOC-1949	1-15/16"	70	30	70	44	1	1,045.0
TOC-1951	2"	72	32	72	54	1	1,205.0
TOC-1952	2-1/16"	72	32	74	54	1	1,325.0
TOC-1954	2-1/8"	72	32	77	54	1	1,332.0
TOC-1956	2-3/16"	74	35	78.5	54	1	1,365.0
TOC-1957	2-1/4"	74	35	80	54	1	1,485.0
TOC-1959	2-5/16"	75	37	82	54	1	1,505.0
TOC-1960	2-3/8"	75	37	84	54	1	1,565.0
TOC-1961	2-7/16"	75	37	86	54	1	1,615.0
TOC-1963	2-1/2"	75	37	88	54	1	1,645.0



WARNING!

Wear safety goggles at all time. [User and bystanders]. Do not use chrome or handtools with power wrenches. Use only impact sockets and accessories with power impact wrenches.

IMPACT SOCKETS

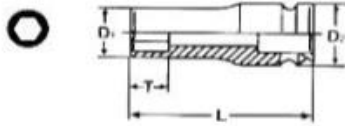

▶ 3/4" Dr Hexagon Deep Sockets

Stock Code	Size	L (MM)	T (MM)	D1 (MM)	D2 (MM)	Qty (Per Box) pcs	Weight (Per Pce) g
QC-1913	13mm	95	20	25	44	6	522.0
QC-1914	14mm	95	20	25	44	6	530.0
QC-1915	15mm	95	20	26	44	6	538.0
QC-1916	16mm	95	20	27	44	6	546.0
QC-1917	17mm	95	20	31	44	6	554.0
QC-1918	18mm	95	20	32	44	6	562.0
QC-1919	19mm	95	23	33	44	6	570.0
QC-1920	20mm	95	23	34	44	6	580.0
QC-1921	21mm	95	23	35	44	6	590.0
QC-1922	22mm	95	23	37	44	6	620.0
QC-1923	23mm	95	23	38	44	6	640.0
QC-1924	24mm	95	23	39	44	6	646.0
QC-1925	25mm	95	23	40	44	6	666.0
QC-1926	26mm	95	23	41	44	6	686.0
QC-1927	27mm	95	29	43	44	6	710.0
QC-1928	28mm	96	29	44	44	6	720.0
QC-1929	29mm	96	29	45	44	6	730.0
QC-1930	30mm	96	29	47	44	6	780.0
QC-1931	31mm	96	29	48	44	6	840.0
QC-1932	32mm	96	29	49	44	6	860.0
QC-1933	33mm	96	29	51	44	6	910.0
QC-1934	34mm	96	37	52	44	6	916.0
QC-1935	35mm	96	37	53	44	6	925.0
QC-1936	36mm	96	37	54	44	6	930.0
QC-1937	37mm	96	37	56	44	6	970.0
QC-1938	38mm	96	37	57	44	6	1,000.0
QC-1939	39mm	96	37	58	44	6	1,030.0
QC-1940	40mm	96	37	58	44	6	1,050.0
QC-1941	41mm	96	37	60	44	6	1,080.0
QC-1942	42mm	96	37	62	44	6	1,130.0
QC-1943	43mm	96	37	63	44	6	1,180.0
QC-1944	44mm	96	37	65	44	6	1,230.0



www.promaxusa.com



WARNING!

Wear safety goggles at all time. [User and bystanders]. Do not use chrome or handtools with power wrenches. Use only impact sockets and accessories with power impact wrenches.

► 3/4" Dr Hexagon Deep Sockets

Stock Code	Size	L (MM)	T (MM)	D1 (MM)	D2 (MM)	Qty (Per Box) pcs	Weight (Per Pce) g
QC-1946	46mm	96	37	67	44	1	1,280.0
QC-1947	47mm	96	37	68	44	1	1,335.0
QC-1948	48mm	96	37	69	44	1	1,390.0
QC-1949	49mm	96	37	70	44	1	1,445.0
QC-1950	50mm	96	37	71	54	1	1,500.0
QC-1952	52mm	96	37	74	54	1	1,610.0
QC-1955	55mm	100	37	77	54	1	1,880.0
QC-1960	60mm	105	37	84	54	1	2,060.0
QC-1965	65mm	105	37	88	54	1	2,180.0
RC-1913	1/2"	85	20	22	38	6	388.0
RC-1914	9/16"	85	20	25.5	38	6	390.0
RC-1916	5/8"	85	20	27.5	38	6	398.0
RC-1917	11/16"	85	20	29	38	6	405.0
RC-1919	3/4"	85	23	30	38	6	410.0
RC-1920	13/16"	85	23	32	38	6	415.0
RC-1922	7/8"	85	23	34	38	6	420.0
RC-1924	15/16"	85	23	36	38	6	430.0
RC-1925	1"	85	23	40	38	6	490.0
RC-1927	1-1/16"	85	23	40	38	6	500.0
RC-1929	1-1/8"	85	30	42	42	6	530.0
RC-1930	1-3/16"	85	30	44	44	6	590.0
RC-1931	1-1/4"	85	30	49	44	6	750.0
RC-1933	1-5/16"	85	35	50	44	6	760.0
RC-1935	1-3/8"	85	35	50	44	6	770.0
RC-1936	1-7/16"	85	37	51	44	6	780.0
RC-1938	1-1/2"	95	37	57	44	6	1,010.0
RC-1940	1-9/16"	95	39	58	44	6	1,020.0
RC-1941	1-5/8"	95	39	60	44	6	1,070.0
RC-1943	1-11/16"	95	39	63	44	6	1,170.0
RC-1944	1-3/4"	95	39	65	44	6	1,220.0
RC-1946	1-13/16"	95	39	67	44	1	1,270.0
RC-1948	1-7/8"	95	39	68	44	1	1,280.0
RC-1949	1-15/16"	95	39	70	44	1	1,340.0
RC-1951	2"	95	39	71	54	1	1,500.0
RC-1952	2-1/16"	95	39	74	54	1	1,690.0
RC-1954	2-1/8"	95	39	77	54	1	1,798.0
RC-1956	2-3/16"	100	39	77	54	1	1,904.0
RC-1957	2-1/4"	100	39	80	54	1	2,012.0
RC-1959	2-5/16"	100	39	82	54	1	2,136.0
RC-1960	2-3/8"	105	39	84	54	1	2,261.0
RC-1961	2-7/16"	105	39	85	54	1	2,383.0
RC-1963	2-1/2"	105	39	86	54	1	2,517.0



www.promaxusa.com



WARNING!

Wear safety goggles at all time. [User and bystanders]. Do not use chrome or handtools with power wrenches
Use only impact sockets and accessories with power impact wrenches

IMPACT SOCKETS

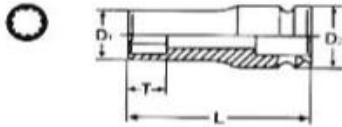

► 3/4" Dr Bi-Hexagon Deep Sockets

Stock Code	Size	L (MM)	T (MM)	D1 (MM)	D2 (MM)	Qty (Per Box) pcs	Weight (Per Pce) g
QC1-1913	13mm	95	13	25	44	6	519.0
QC1-1914	14mm	95	14	25	44	6	527.0
QC1-1915	15mm	95	15	26	44	6	535.0
QC1-1916	16mm	95	16	27	44	6	543.0
QC1-1917	17mm	95	17	31	44	6	551.0
QC1-1918	18mm	95	18	32	44	6	559.0
QC1-1919	19mm	95	19	33	44	6	567.0
QC1-1920	20mm	95	20	34	44	6	577.0
QC1-1921	21mm	95	21	35	44	6	587.0
QC1-1922	22mm	95	22	37	44	6	617.0
QC1-1923	23mm	95	23	38	44	6	637.0
QC1-1924	24mm	95	24	39	44	6	643.0
QC1-1925	25mm	95	25	40	44	6	663.0
QC1-1926	26mm	95	26	41	44	6	683.0
QC1-1927	27mm	95	27	43	44	6	707.0
QC1-1928	28mm	96	28	44	44	6	717.0
QC1-1929	29mm	96	29	45	44	6	727.0
QC1-1930	30mm	96	30	47	44	6	777.0
QC1-1931	31mm	96	31	48	44	6	837.0
QC1-1932	32mm	96	32	49	44	6	857.0
QC1-1933	33mm	96	33	51	44	6	907.0
QC1-1934	34mm	96	34	52	44	6	913.0
QC1-1935	35mm	96	35	53	44	6	922.0
QC1-1936	36mm	96	36	54	44	6	927.0
QC1-1937	37mm	96	37	56	44	6	967.0
QC1-1938	38mm	96	38	57	44	6	997.0
QC1-1939	39mm	96	38	58	44	6	1,027.0
QC1-1940	40mm	96	38	58	44	6	1,047.0
QC1-1941	41mm	96	38	60	44	6	1,077.0
QC1-1942	42mm	96	38	62	44	6	1,127.0
QC1-1943	43mm	96	38	63	44	6	1,177.0



WARNING!

Wear safety goggles at all time. [User and bystanders]. Do not use chrome or handtools with power wrenches. Use only impact sockets and accessories with power impact wrenches.

IMPACT SOCKETS

► 3/4" Dr Bi-Hexagon Deep Sockets

Stock Code	Size	L (MM)	T (MM)	D1 (MM)	D2 (MM)	Qty (Per Box) pcs	Weight (Per Pce) g
QC1-1944	44mm	96	38	65	44	6	1,227.0
QC1-1946	46mm	100	38	67	44	1	1,277.0
QC1-1947	47mm	100	38	68	44	1	1,332.0
QC1-1948	48mm	100	38	69	44	1	1,387.0
QC1-1949	49mm	100	38	70	44	1	1,442.0
QC1-1950	50mm	100	38	71	54	1	1,497.0
QC1-1952	52mm	100	40	74	54	1	1,607.0
QC1-1955	55mm	105	40	77	54	1	1,877.0
QC1-1960	60mm	105	42	84	54	1	2,057.0
QC1-1965	65mm	105	66	90	54	1	2,177.0
RC1-1913	1/2"	95	13	24.5	44	6	385.0
RC1-1914	9/16"	95	14	25.5	44	6	387.0
RC1-1916	5/8"	95	16	27.5	44	6	395.0
RC1-1917	11/16"	95	17	31	44	6	402.0
RC1-1919	3/4"	95	19	33	44	6	407.0
RC1-1920	13/16"	95	22	35	44	6	412.0
RC1-1922	7/8"	95	22	37	44	6	417.0
RC1-1924	15/16"	95	24	39	44	6	427.0
RC1-1925	1"	95	25	40	44	6	487.0
RC1-1927	1-1/16"	95	27	43	44	6	497.0
RC1-1929	1-1/8"	95	29	44.5	44	6	527.0
RC1-1930	1-3/16"	95	30	47	44	6	587.0
RC1-1931	1-1/4"	95	32	49	44	6	747.0
RC1-1933	1-5/16"	95	34	50	44	6	757.0
RC1-1935	1-3/8"	95	35	53	44	6	767.0
RC1-1936	1-7/16"	95	37	55	44	6	777.0
RC1-1938	1-1/2"	95	38	57	44	6	1,007.0
RC1-1940	1-9/16"	95	38	58	44	6	1,017.0
RC1-1941	1-5/8"	95	38	60	44	6	1,067.0
RC1-1943	1-11/16"	95	38	63	44	6	1,167.0
RC1-1944	1-3/4"	95	38	65	44	6	1,217.0
RC1-1946	1-13/16"	100	38	67	44	1	1,267.0
RC1-1948	1-7/8"	100	38	68	44	1	1,277.0
RC1-1949	1-15/16"	100	38	70	44	1	1,337.0
RC1-1951	2"	100	40	71	54	1	1,497.0
RC1-1952	2-1/16"	100	40	74	54	1	1,687.0
RC1-1954	2-1/8"	100	40	77	54	1	1,795.0



www.promaxusa.com



WARNING!

Wear safety goggles at all time. [User and bystanders]. Do not use chrome or handtools with power wrenches. Use only impact sockets and accessories with power impact wrenches.

IMPACT SOCKETS

▶ 3/4"Dr Bi-Hexagon Deep Sockets

Stock Code	Size	L (MM)	T (MM)	D1 (MM)	D2 (MM)	Qty (Per Box) pcs	Weight (Per Pce) g
RC1-1956	2-3/16"	105	40	78	54	1	1,901.0
RC1-1957	2-1/4"	105	40	80	54	1	2,009.0
RC1-1959	2-5/16"	105	40	82	54	1	2,133.0
RC1-1960	2-3/8"	105	42	84	54	1	2,258.0
RC1-1961	2-7/16"	105	42	85	54	1	2,380.0
RC1-1963	2-1/2"	105	42	88	54	1	2,514.0

▶ 1"Dr Hexagon Regular Sockets

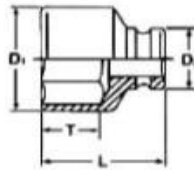

Stock Code	Size	L (MM)	T (MM)	D1 (MM)	D2 (MM)	Qty (Per Box) pcs	Weight (Per Pce) g
ND-2517	17mm	59	17	34	51	6	480.0
ND-2518	18mm	59	17	34.5	51	6	485.0
ND-2519	19mm	59	17	35.5	51	6	500.0
ND-2520	20mm	59	17	36.5	51	6	505.0
ND-2521	21mm	59	17	37.5	51	6	510.0
ND-2522	22mm	59	17	39	51	6	514.0
ND-2523	23mm	59	17	40	51	6	520.0
ND-2524	24mm	59	17	40	51	6	526.0
ND-2525	25mm	59	17	41	51	6	532.0
ND-2526	26mm	59	17	43	52	6	540.0
ND-2527	27mm	59	17	44	52	6	547.0
ND-2528	28mm	59	17	45	52	6	552.0
ND-2529	29mm	61	19	46	52	6	560.0
ND-2530	30mm	61	21	48	52	6	565.0
ND-2531	31mm	61	21	49	52	6	570.0
ND-2532	32mm	61	21	51	52	6	576.0



WARNING!

Wear safety goggles at all time. [User and bystanders]. Do not use chrome or handtools with power wrenches. Use only impact sockets and accessories with power impact wrenches.

► 1" Dr Hexagon Regular Sockets

Stock Code	Size	L (MM)	T (MM)	D1 (MM)	D2 (MM)	Qty (Per Box) pcs	Weight (Per Pce) g
ND-2533	33mm	63	21	53	53	6	630.0
ND-2534	34mm	63	21	55	53	6	640.0
ND-2535	35mm	63	21	55	53	6	645.0
ND-2536	36mm	63	26	56	53	6	660.0
ND-2537	37mm	63	26	57	53	6	670.0
ND-2538	38mm	63	26	58	53	6	680.0
ND-2539	39mm	63	26	59	53	6	690.0
ND-2540	40mm	63	26	61	53	6	700.0
ND-2541	41mm	63	26	62	53	6	740.0
ND-2542	42mm	64	27	63	53	6	760.0
ND-2543	43mm	64	27	66	53	6	830.0
ND-2544	44mm	64	27	66	53	6	840.0
ND-2545	45mm	65	27	67	58	6	890.0
ND-2546	46mm	65	27	68	58	6	950.0
ND-2547	47mm	66	28	69	58	6	1,000.0
ND-2548	48mm	68	30	70	58	6	1,010.0
ND-2550	50mm	71	30	72	58	1	1,130.0
ND-2551	51mm	71	30.5	75	58	1	1,150.0
ND-2552	52mm	71	31	76	58	1	1,180.0
ND-2553	53mm	71	31	76	58	1	1,190.0
ND-2554	54mm	71	31	79	58	1	1,240.0
ND-2555	55mm	73	32	80	62	1	1,370.0
ND-2556	56mm	73	34	81	62	1	1,400.0
ND-2557	57mm	76	35	84	62	1	1,580.0
ND-2558	58mm	76	35	85	62	1	1,600.0
ND-2560	60mm	79	35	87	62	1	1,700.0
ND-2563	63mm	80	36	90	62	1	1,870.0
ND-2565	65mm	80	36	92	62	1	1,910.0
ND-2567	67mm	83	38	95	62	1	2,040.0
ND-2570	70mm	85	40	98	62	1	2,730.0
ND-2571	71mm	87	40	100	62	1	3,100.0
ND-2575	75mm	99	52	104	86	1	3,640.0
ND-2580	80mm	101	52	109	86	1	4,010.0
ND-2585	85mm	101	52	115	86	1	4,460.0
ND-2590	90mm	105	55	125	86	1	4,870.0
ND-2595	95mm	105	55	130	86	1	5,940.0
ND-25100	100mm	105	55	137	95	1	6,170.0
ND-25105	105mm	105	55	143	95	1	6,450.0
ND-25110	110mm	105	55	147	95	1	6,900.0
ND-25115	115mm	105	55	152	95	1	7,350.0



WARNING!

Wear safety goggles at all time. [User and bystanders]. Do not use chrome or handtools with power wrenches
Use only impact sockets and accessories with power impact wrenches

► 1" Dr Hexagon Regular Sockets

Stock Code	Size	L (MM)	T (MM)	D1 (MM)	D2 (MM)	Qty (Per Box) pcs	Weight (Per Pce) g
OD-2516	5/8"	59	17	32	51	6	460.0
OD-2517	11/16"	59	17	34	51	6	470.0
OD-2519	3/4"	59	17	36	51	6	480.0
OD-2521	13/16"	59	17	38	51	6	490.0
OD-2522	7/8"	59	17	39	51	6	497.0
OD-2524	15/16"	59	17	40	51	6	502.0
OD-2525	1"	59	17	42	51	6	508.0
OD-2527	1-1/16"	59	17	44	51	6	513.0
OD-2529	1-1/8"	59	19	46	51	6	530.0
OD-2530	1-3/16"	60	21	48	51	6	550.0
OD-2532	1-1/4"	61	21	51	51	6	560.0
OD-2533	1-5/16"	63	21	53	52	6	620.0
OD-2535	1-3/8"	63	21	54	52	6	630.0
OD-2536	1-7/16"	63	26	56	52	6	640.0
OD-2538	1-1/2"	63	26	58	52	6	670.0
OD-2540	1-9/16"	63	26	60	52	6	690.0
OD-2541	1-5/8"	63	26	61.5	52	6	710.0
OD-2543	1-11/16"	65	27	65	52	6	820.0
OD-2544	1-3/4"	65	27	66	58	6	910.0
OD-2546	1-13/16"	65	27	68	58	6	940.0
OD-2548	1-7/8"	67	28	70	58	6	1,000.0
OD-2549	1-15/16"	69	28	72	58	6	1,040.0
OD-2551	2"	71	31	74	58	6	1,150.0
OD-2552	2-1/16"	71	31	75	58	6	1,180.0
OD-2554	2-1/8"	71	31	78	58	1	1,220.0
OD-2556	2-3/16"	73	32	80	62	1	1,420.0
OD-2557	2-1/4"	76	34	84	62	1	1,570.0
OD-2559	2-5/16"	76	34	86	62	1	1,610.0
OD-2560	2-3/8"	79	35	87	62	1	1,690.0
OD-2562	2-7/16"	79	35	89	62	1	1,780.0
OD-2563	2-1/2"	81	36	91	62	1	1,830.0
OD-2565	2-9/16"	81	36	93	62	1	1,920.0
OD-2567	2-5/8"	83	38	95	62	1	2,020.0
OD-2568	2-11/16"	83	38	97	62	1	2,060.0
OD-2570	2-3/4"	85	40	98	62	1	2,750.0
OD-2572	2-13/16"	87	40	100	62	1	2,800.0
OD-2573	2-7/8"	87	41	102	62	1	3,600.0
OD-2575	2-15/16"	96	48	104	86	1	3,650.0
OD-2576	3"	99	52	106	86	1	3,740.0
OD-2579	3-1/8"	101	52	109	86	1	3,980.0
OD-2584	3-1/4"	101	52	113	86	1	4,020.0

**WARNING!**

Wear safety goggles at all time. [User and bystanders]. Do not use chrome or handtools with power wrenches
Use only impact sockets and accessories with power impact wrenches

IMPACT SOCKETS

► 1"Dr Hexagon Regular Sockets

Stock Code	Size	L (MM)	T (MM)	D1 (MM)	D2 (MM)	Qty (Per Box) pcs	Weight (Per Pce) g
OD-2585	3-3/8"	101	52	115	86	1	4,430.0
OD-2588	3-1/2"	105	52	125	86	1	4,920.0
OD-2591	3-5/8"	105	52	127	86	1	5,260.0
OD-2594	3-3/4"	105	52	130	86	1	5,550.0
OD-2597	3-7/8"	105	52	136	95	1	5,840.0
OD-25100	4"	105	52	140	95	1	6,130.0
OD-25103	4-1/8"	105	52	143	95	1	6,430.0
OD-25106	4-1/4"	105	52	146	95	1	6,750.0
OD-25113	4-1/2"	105	52	152	95	1	7,100.0

► 1"Dr Bi-Hexagon Regular Sockets

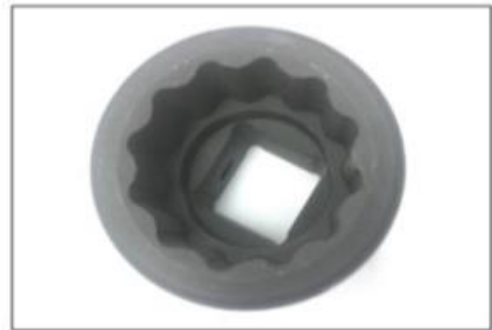
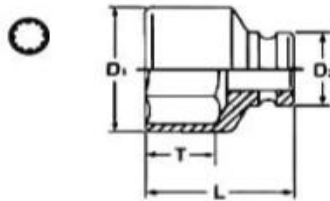

Stock Code	Size	L (MM)	T (MM)	D1 (MM)	D2 (MM)	Qty (Per Box) pcs	Weight (Per Pce) g
TND-2517	17mm	60	12	34	54	6	490.0
TND-2518	18mm	60	13	35	54	6	495.0
TND-2519	19mm	60	13	36	54	6	510.0
TND-2520	20mm	60	14	37	54	6	515.0
TND-2521	21mm	60	15	38	54	6	520.0
TND-2522	22mm	60	15	40	54	6	525.0
TND-2523	23mm	60	16	41	54	6	530.0
TND-2524	24mm	60	18	42	54	6	536.0
TND-2525	25mm	60	18	43	54	6	542.0
TND-2526	26mm	60	18	44.5	54	6	550.0
TND-2527	27mm	60	19	46	54	6	555.0
TND-2528	28mm	62	19	47	54	6	560.0
TND-2529	29mm	62	19	48	54	6	570.0
TND-2530	30mm	62	21	50	54	6	575.0
TND-2531	31mm	62	21	51	54	6	580.0



www.promaxusa.com



WARNING!

Wear safety goggles at all time. [User and bystanders]. Do not use chrome or handtools with power wrenches
Use only impact sockets and accessories with power impact wrenches

IMPACT SOCKETS

▶ 1" Dr Bi-Hexagon Regular Sockets

Stock Code	Size	L (MM)	T (MM)	D1 (MM)	D2 (MM)	Qty (Per Box) pcs	Weight (Per Pce) g
TND-2532	32mm	62	22	52	54	6	590.0
TND-2533	33mm	62	22	53	54	6	640.0
TND-2534	34mm	62	22	55	54	6	650.0
TND-2535	35mm	65	22	56	54	6	655.0
TND-2536	36mm	67	25	57	54	6	670.0
TND-2537	37mm	67	25	59	54	6	690.0
TND-2538	38mm	67	25	60	54	6	700.0
TND-2539	39mm	70	25	61	54	6	710.0
TND-2540	40mm	70	25	62	54	6	720.0
TND-2541	41mm	70	27	63	54	6	760.0
TND-2542	42mm	74	27	65	54	6	780.0
TND-2543	43mm	74	27	66	54	6	850.0
TND-2544	44mm	74	27	67	54	6	860.0
TND-2545	45mm	74	27	68	54	6	910.0
TND-2546	46mm	76	30	70	58	6	970.0
TND-2547	47mm	76	32	71.5	58	6	1,020.0
TND-2548	48mm	76	32	72.5	58	6	1,030.0
TND-2550	50mm	80	35	75	62	1	1,150.0
TND-2551	51mm	80	35	76	62	1	1,170.0
TND-2552	52mm	84	35	77	62	1	1,200.0
TND-2553	53mm	84	35	78	62	1	1,210.0
TND-2554	54mm	84	35	80	62	1	1,260.0
TND-2555	55mm	84	35	81	62	1	1,400.0
TND-2556	56mm	84	40	82	62	1	1,430.0
TND-2557	57mm	84	40	84	62	1	1,610.0
TND-2558	58mm	87	40	85	62	1	1,630.0
TND-2560	60mm	87	42	87	62	1	1,730.0
TND-2562	62mm	87	42	89	62	1	1,900.0
TND-2563	63mm	87	42	90	62	1	1,940.0
TND-2565	65mm	90	42	93	62	1	2,070.0
TND-2567	67mm	92	42	96	62	1	2,760.0
TND-2570	70mm	96	42	100	62	1	3,130.0
TND-2575	75mm	98	45	106	86	1	3,670.0
TND-2580	80mm	100	48	112	86	1	4,040.0
TND-2585	85mm	105	52	118	86	1	4,490.0
TND-2590	90mm	105	52	125	86	1	4,900.0
TND-2595	95mm	115	52	131	86	1	5,970.0
TND-25100	100mm	115	58	137	86	1	6,200.0
TND-25105	105mm	115	58	143	95	1	6,480.0
TND-25110	110mm	115	60	149	95	1	6,930.0



WARNING!

Wear safety goggles at all time. [User and bystanders]. Do not use chrome or handtools with power wrenches. Use only impact sockets and accessories with power impact wrenches.

IMPACT SOCKETS

► 1" Dr Bi-Hexagon Regular Sockets

Stock Code	Size	L (MM)	T (MM)	D1 (MM)	D2 (MM)	Qty (Per Box) pcs	Weight (Per Pce) g
TND-25115	115mm	115	62	155	95	1	7,380.0
TOD-2516	5/8"	60	11	32	54	6	470.0
TOD-2517	11/16"	60	12	34	54	6	480.0
TOD-2519	3/4"	60	13	36	54	6	490.0
TOD-2521	13/16"	60	15	38	54	6	500.0
TOD-2522	7/8"	60	15	39	54	6	507.0
TOD-2524	15/16"	60	18	42	54	6	512.0
TOD-2525	1"	60	18	44	54	6	515.0
TOD-2527	1-1/16"	60	19	46	54	6	525.0
TOD-2529	1-1/8"	62	19	48	54	6	540.0
TOD-2530	1-3/16"	62	21	50	54	6	560.0
TOD-2532	1-1/4"	62	22	52	54	6	570.0
TOD-2533	1-5/16"	62	22	54	54	6	630.0
TOD-2535	1-3/8"	65	22	56	54	6	640.0
TOD-2536	1-7/16"	67	25	58	54	6	650.0
TOD-2538	1-1/2"	67	25	60	54	6	680.0
TOD-2540	1-9/16"	70	25	62	54	6	700.0
TOD-2541	1-5/8"	70	27	63	54	6	720.0
TOD-2543	1-11/16"	74	27	66	54	6	830.0
TOD-2544	1-3/4"	74	27	67	54	6	920.0
TOD-2546	1-13/16"	76	30	70	58	6	960.0
TOD-2548	1-7/8"	76	32	72	58	6	1,020.0
TOD-2549	1-15/16"	80	32	74	58	6	1,060.0
TOD-2551	2"	80	35	76	62	1	1,170.0
TOD-2552	2-1/16"	84	35	77	62	1	1,200.0
TOD-2554	2-1/8"	84	35	80	62	1	1,240.0
TOD-2556	2-3/16"	84	35	81	62	1	1,440.0
TOD-2557	2-1/4"	84	40	84	62	1	1,590.0
TOD-2559	2-5/16"	87	40	86	62	1	1,630.0
TOD-2560	2-3/8"	87	42	87	62	1	1,710.0
TOD-2562	2-7/16"	87	42	89	62	1	1,800.0
TOD-2563	2-1/2"	87	42	91	62	1	1,850.0
TOD-2565	2-9/16"	90	42	93	62	1	1,940.0
TOD-2567	2-5/8"	92	42	95	62	1	2,040.0
TOD-2568	2-11/16"	92	42	97	62	1	2,080.0
TOD-2570	2-3/4"	96	42	100	62	1	2,770.0
TOD-2572	2-13/16"	96	45	102	62	1	2,820.0
TOD-2573	2-7/8"	96	45	104	86	1	3,620.0
TOD-2575	2-15/16"	98	45	105	86	1	3,670.0



www.promaxusa.com



WARNING!

Wear safety goggles at all time. [User and bystanders]. Do not use chrome or handtools with power wrenches. Use only impact sockets and accessories with power impact wrenches.

IMPACT SOCKETS

► 1"Dr Bi-Hexagon Regular Sockets

Stock Code	Size	L (MM)	T (MM)	D1 (MM)	D2 (MM)	Qty (Per Box) pcs	Weight (Per Pce) g
TOD-2576	3"	100	48	107	86	1	3,760.0
TOD-2579	3-1/8"	100	48	111	86	1	4,010.0
TOD-2584	3-1/4"	100	48	115	86	1	4,050.0
TOD-2585	3-3/8"	105	52	119	86	1	4,460.0
TOD-2588	3-1/2"	105	52	124	86	1	4,950.0
TOD-2592	3-5/8"	105	52	127	86	1	5,290.0
TOD-2595	3-3/4"	115	52	131	86	1	5,580.0
TOD-2598	3-7/8"	115	58	135	86	1	5,870.0
TOD-25101	4"	115	58	139	86	1	6,160.0
TOD-25104	4-1/8"	115	58	143	95	1	6,460.0
TOD-25107	4-1/4"	115	60	147	95	1	6,780.0
TOD-25114	4-1/2"	115	62	154	95	1	7,130.0

► 1"Dr Hexagon Deep Sockets

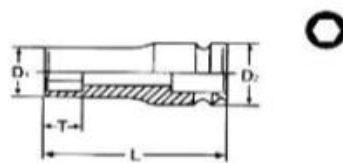

Stock Code	Size	L (MM)	T (MM)	D1 (MM)	D2 (MM)	Qty (Per Box) pcs	Weight (Per Pce) g
QD-2517	17mm	100	21	34	54	6	816.0
QD-2518	18mm	100	21	34.5	54	6	825.0
QD-2519	19mm	100	21	35.5	54	6	850.0
QD-2520	20mm	100	21	36.5	54	6	860.0
QD-2521	21mm	100	21	37.5	54	6	870.0
QD-2522	22mm	100	21	40	54	6	875.0
QD-2523	23mm	100	21	41	54	6	884.0
QD-2524	24mm	100	21	42	54	6	910.0



WARNING!

Wear safety goggles at all time. [User and bystanders]. Do not use chrome or handtools with power wrenches. Use only impact sockets and accessories with power impact wrenches.

IMPACT SOCKETS

► 1"Dr Hexagon Deep Sockets

Stock Code	Size	L (MM)	T (MM)	D1 (MM)	D2 (MM)	Qty (Per Box) pcs	Weight (Per Pce) g
QD-2525	25mm	100	21	43	54	6	950.0
QD-2526	26mm	100	21	44	54	6	980.0
QD-2527	27mm	100	23	46	54	6	1,040.0
QD-2528	28mm	100	23	47	54	6	1,050.0
QD-2529	29mm	100	23	48	54	6	1,060.0
QD-2530	30mm	100	29	50	54	6	1,070.0
QD-2531	31mm	100	29	51	54	6	1,080.0
QD-2532	32mm	100	33	52	54	6	1,090.0
QD-2533	33mm	100	34	53	54	6	1,110.0
QD-2534	34mm	100	34	55	54	6	1,150.0
QD-2535	35mm	100	34	55	54	6	1,190.0
QD-2536	36mm	100	36	56	54	6	1,200.0
QD-2537	37mm	100	36	59	54	6	1,230.0
QD-2538	38mm	100	36	59	54	6	1,280.0
QD-2539	39mm	100	36	60	54	6	1,300.0
QD-2540	40mm	100	36	62	54	6	1,330.0
QD-2541	41mm	100	36	63	54	6	1,360.0
QD-2542	42mm	100	36	64	54	6	1,400.0
QD-2543	43mm	100	36	65	54	6	1,460.0
QD-2544	44mm	100	36	67	54	6	1,520.0
QD-2545	45mm	100	36	68	54	1	1,560.0
QD-2546	46mm	100	38	69	54	1	1,600.0
QD-2547	47mm	100	38	72	54	1	1,650.0
QD-2548	48mm	100	38	73	54	1	1,720.0
QD-2550	50mm	100	38	74	54	1	1,790.0
QD-2551	51mm	100	41	75	54	1	1,830.0
QD-2552	52mm	100	41	77	54	1	1,880.0
QD-2553	53mm	100	41	78	54	1	1,920.0
QD-2554	54mm	100	41	79	54	1	1,960.0
QD-2555	55mm	100	41	80	54	1	2,010.0
QD-2556	56mm	105	45	81	54	1	2,160.0
QD-2557	57mm	105	45	82	54	1	2,320.0
QD-2558	58mm	105	45	84	54	1	2,500.0
QD-2560	60mm	120	45	86	54	1	2,710.0
QD-2562	62mm	120	45	88	54	1	2,900.0
QD-2563	63mm	120	45	90	54	1	3,080.0
QD-2565	65mm	125	45	92	54	1	3,220.0
QD-2567	67mm	125	45	95	54	1	3,450.0
QD-2570	70mm	135	45	99	54	1	3,640.0
QD-2575	75mm	135	45	104	86	1	5,080.0



WARNING!

Wear safety goggles at all time. [User and bystanders]. Do not use chrome or handtools with power wrenches. Use only impact sockets and accessories with power impact wrenches.

► 1" Dr Hexagon Deep Sockets

Stock Code	Size	L (MM)	T (MM)	D1 (MM)	D2 (MM)	Qty (Per Box) pcs	Weight (Per Pce) g
QD-2580	80mm	135	48	109	86	1	5,510.0
QD-2585	85mm	140	53	115	86	1	6,320.0
QD-2590	90mm	140	53	125	86	1	6,830.0
QD-2595	95mm	140	53	130	86	1	7,060.0
QD-25100	100mm	140	58	137	95	1	8,250.0
QD-25105	105mm	155	58	143	95	1	8,600.0
QD-25110	110mm	155	58	147	95	1	9,200.0
QD-25115	115mm	155	58	152	95	1	10,500.0
RD-2516	5/8"	90	21	32	51	6	715.0
RD-2517	11/16"	90	21	34	51	6	730.0
RD-2519	3/4"	90	21	36	51	6	745.0
RD-2520	13/16"	90	21	38	51	6	760.0
RD-2522	7/8"	90	21	39	51	6	770.0
RD-2524	15/16"	90	21	40	51	6	780.0
RD-2525	1"	90	21	42	51	6	790.0
RD-2527	1-1/16"	90	23	44	51	6	795.0
RD-2529	1-1/8"	90	40	46	51	6	830.0
RD-2530	1-3/16"	90	40	48	51	6	840.0
RD-2532	1-1/4"	90	40	51	51	6	850.0
RD-2533	1-5/16"	90	40	53	52	6	900.0
RD-2535	1-3/8"	90	40	54	52	6	940.0
RD-2536	1-7/16"	90	40	56	52	6	960.0
RD-2538	1-1/2"	92	40	58	52	6	1,000.0
RD-2540	1-9/16"	92	40	60	52	6	1,040.0
RD-2541	1-5/8"	92	40	61.5	52	6	1,120.0
RD-2543	1-11/16"	92	40	65	52	6	1,250.0
RD-2544	1-3/4"	92	40	66	58	6	1,300.0
RD-2546	1-13/16"	92	40	68	58	1	1,400.0
RD-2548	1-7/8"	92	40	70	58	1	1,410.0
RD-2549	1-15/16"	92	40	72	58	1	1,460.0
RD-2551	2"	95	40	74	58	1	1,640.0
RD-2552	2-1/16"	95	40	75	58	1	1,650.0
RD-2554	2-1/8"	100	40	78	58	1	1,740.0
RD-2556	2-3/16"	100	43	80	62	1	2,020.0
RD-2557	2-1/4"	100	43	84	62	1	2,230.0
RD-2559	2-5/16"	105	43	86	62	1	2,300.0
RD-2560	2-3/8"	105	43	87	62	1	2,460.0
RD-2562	2-7/16"	110	43	89	62	1	2,760.0
RD-2563	2-1/2"	110	43	91	62	1	2,860.0
RD-2565	2-9/16"	120	43	93	62	1	3,390.0
RD-2567	2-5/8"	120	43	95	62	1	3,450.0
RD-2568	2-11/16"	124	43	97	62	1	3,620.0
RD-2570	2-3/4"	124	43	98	62	1	3,790.0



WARNING!

Wear safety goggles at all time. [User and bystanders]. Do not use chrome or handtools with power wrenches. Use only impact sockets and accessories with power impact wrenches.

IMPACT SOCKETS

► 1"Dr Hexagon Deep Sockets

Stock Code	Size	L (MM)	T (MM)	D1 (MM)	D2 (MM)	Qty (Per Box) pcs	Weight (Per Pce) g
RD-2572	2-13/16"	128	46	100	62	1	3,900.0
RD-2573	2-7/8"	128	46	102	62	1	4,660.0
RD-2575	2-15/16"	135	46	104	86	1	4,970.0
RD-2576	3"	135	48	106	86	1	5,140.0
RD-2579	3-1/8"	135	48	109	86	1	5,410.0
RD-2584	3-1/4"	135	48	113	86	1	5,680.0
RD-2585	3-3/8"	140	53	115	86	1	6,240.0
RD-2588	3-1/2"	140	53	125	86	1	6,830.0
RD-2591	3-5/8"	140	53	127	86	1	7,140.0
RD-2594	3-3/4"	140	53	130	86	1	7,360.0
RD-2597	3-7/8"	140	56	136	95	1	7,550.0
RD-25100	4"	155	56	140	95	1	8,670.0
RD-25103	4-1/8"	155	60	143	95	1	9,600.0
RD-25106	4-1/4"	155	60	146	95	1	10,750.0
RD-25113	4-1/2"	155	60	152	95	1	11,800.0

► 1"Dr Bi-Hexagon Deep Sockets

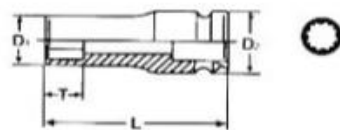
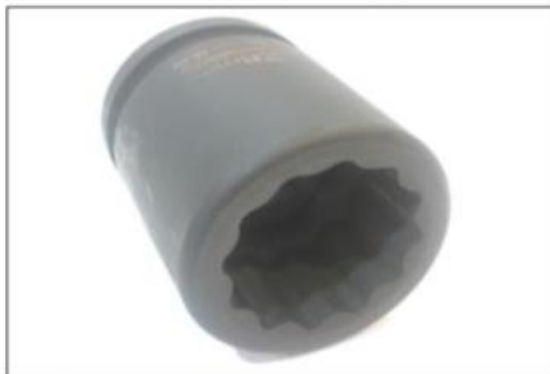

Stock Code	Size	L (MM)	T (MM)	D1 (MM)	D2 (MM)	Qty (Per Box) pcs	Weight (Per Pce) g
QD1-2517	17mm	100	17	34	54	6	826.0
QD1-2518	18mm	100	18	35	54	6	835.0
QD1-2519	19mm	100	19	36	54	6	860.0
QD1-2520	20mm	100	20	37	54	6	870.0
QD1-2521	21mm	100	21	38	54	6	880.0
QD1-2522	22mm	100	22	40	54	6	885.0
QD1-2523	23mm	100	23	41	54	6	894.0



www.promaxusa.com



WARNING!

Wear safety goggles at all time. [User and bystanders]. Do not use chrome or handtools with power wrenches
Use only impact sockets and accessories with power impact wrenches.

► 1" Dr Bi-Hexagon Deep Sockets

Stock Code	Size	L (MM)	T (MM)	D1 (MM)	D2 (MM)	Qty (Per Box) pcs	Weight (Per Pce) g
QD1-2524	24mm	100	24	42	54	6	920.0
QD1-2525	25mm	100	25	43	54	6	960.0
QD1-2526	26mm	100	26	44.5	54	6	990.0
QD1-2527	27mm	100	27	46	54	6	1,050.0
QD1-2528	28mm	100	28	47	54	6	1,060.0
QD1-2529	29mm	100	29	48	54	6	1,070.0
QD1-2530	30mm	100	30	50	54	6	1,080.0
QD1-2531	31mm	100	31	51	54	6	1,090.0
QD1-2532	32mm	100	32	52	54	6	1,100.0
QD1-2533	33mm	100	33	53	54	6	1,120.0
QD1-2534	34mm	100	34	55	54	6	1,160.0
QD1-2535	35mm	100	35	56	54	6	1,200.0
QD1-2536	36mm	100	36	57	54	6	1,210.0
QD1-2537	37mm	100	37	59	54	6	1,240.0
QD1-2538	38mm	100	38	60	54	6	1,290.0
QD1-2539	39mm	100	38	61	54	6	1,310.0
QD1-2540	40mm	100	38	62	54	6	1,340.0
QD1-2541	41mm	100	38	63	54	6	1,370.0
QD1-2542	42mm	100	38	65	54	6	1,410.0
QD1-2543	43mm	100	38	66	54	6	1,470.0
QD1-2544	44mm	100	38	67	54	6	1,530.0
QD1-2545	45mm	100	38	68	54	1	1,570.0
QD1-2546	46mm	100	38	70	58	1	1,610.0
QD1-2547	47mm	100	38	71.5	58	1	1,660.0
QD1-2548	48mm	100	38	72.5	58	1	1,730.0
QD1-2550	50mm	100	38	75	62	1	1,800.0
QD1-2551	51mm	100	40	76	62	1	1,840.0
QD1-2552	52mm	100	40	77	62	1	1,890.0
QD1-2553	53mm	100	40	78	62	1	1,930.0
QD1-2554	54mm	100	40	80	62	1	1,970.0
QD1-2555	55mm	100	40	81	62	1	2,020.0
QD1-2556	56mm	105	40	82	62	1	2,170.0
QD1-2557	57mm	105	40	84	62	1	2,330.0
QD1-2558	58mm	105	40	85	62	1	2,510.0
QD1-2560	60mm	120	42	87	62	1	2,720.0
QD1-2562	62mm	120	42	89	62	1	2,910.0
QD1-2563	63mm	120	42	90	62	1	3,090.0
QD1-2565	65mm	125	42	93	62	1	3,230.0
QD1-2567	67mm	125	42	96	62	1	3,460.0
QD1-2570	70mm	125	42	100	62	1	3,650.0
QD1-2575	75mm	135	45	106	86	1	5,090.0
QD1-2580	80mm	135	48	112	86	1	5,520.0
QD1-2585	85mm	140	52	118	86	1	6,330.0

**WARNING!**

Wear safety goggles at all time. [User and bystanders]. Do not use chrome or handtools with power wrenches
Use only impact sockets and accessories with power impact wrenches

► 1" Dr Bi-Hexagon Deep Sockets

Stock Code	Size	L (MM)	T (MM)	D1 (MM)	D2 (MM)	Qty (Per Box) pcs	Weight (Per Pce) g
QD1-2590	90mm	140	52	125	86	1	6,840.0
QD1-2595	95mm	140	52	131	86	1	7,070.0
QD1-25100	100mm	140	58	137	86	1	8,260.0
QD1-25105	105mm	155	58	143	95	1	8,610.0
QD1-25110	110mm	155	60	149	95	1	9,210.0
QD1-25115	115mm	155	62	155	95	1	10,510.0
RD1-2516	5/8"	100	16	32	54	6	725.0
RD1-2517	11/16"	100	17	34	54	6	740.0
RD1-2519	3/4"	100	19	36	54	6	755.0
RD1-2521	13/16"	100	22	38	54	6	770.0
RD1-2522	7/8"	100	22	39	54	6	780.0
RD1-2524	15/16"	100	24	42	54	6	790.0
RD1-2525	1"	100	25	44	54	6	800.0
RD1-2527	1-1/16"	100	27	46	54	6	805.0
RD1-2529	1-1/8"	100	29	48	54	6	840.0
RD1-2530	1-3/16"	100	30	50	54	6	850.0
RD1-2532	1-1/4"	100	32	52	54	6	860.0
RD1-2533	1-5/16"	100	34	54	54	6	910.0
RD1-2535	1-3/8"	100	35	56	54	6	950.0
RD1-2536	1-7/16"	100	37	58	54	6	970.0
RD1-2538	1-1/2"	100	38	60	54	6	1,010.0
RD1-2540	1-9/16"	100	38	62	54	6	1,050.0
RD1-2541	1-5/8"	100	38	63.5	54	6	1,130.0
RD1-2543	1-11/16"	100	38	66	54	6	1,260.0
RD1-2544	1-3/4"	100	38	67.5	54	6	1,310.0
RD1-2546	1-13/16"	100	38	70	62	1	1,410.0
RD1-2548	1-7/8"	100	38	72	62	1	1,420.0
RD1-2549	1-15/16"	100	38	74	62	1	1,470.0
RD1-2551	2"	100	40	76	62	1	1,650.0
RD1-2552	2-1/16"	100	40	77.5	62	1	1,660.0
RD1-2554	2-1/8"	100	40	80	62	1	1,750.0
RD1-2556	2-3/16"	100	40	81.5	62	1	2,030.0
RD1-2557	2-1/4"	105	40	84	62	1	2,240.0
RD1-2559	2-5/16"	105	40	86	62	1	2,310.0
RD1-2560	2-3/8"	120	42	87	62	1	2,470.0
RD1-2562	2-7/16"	120	42	89	62	1	2,770.0
RD1-2563	2-1/2"	120	42	91	62	1	2,870.0
RD1-2565	2-9/16"	125	42	93	62	1	3,400.0
RD1-2567	2-5/8"	125	42	95	62	1	3,460.0
RD1-2568	2-11/16"	125	42	97	62	1	3,630.0
RD1-2570	2-3/4"	125	42	100	62	1	3,800.0
RD1-2572	2-13/16"	125	45	102	62	1	3,910.0



www.promaxusa.com



WARNING!

Wear safety goggles at all time. [User and bystanders]. Do not use chrome or handtools with power wrenches. Use only impact sockets and accessories with power impact wrenches.

IMPACT SOCKETS

► 1" Bi-Dr Hexagon Deep Sockets

Stock Code	Size	L (MM)	T (MM)	D1 (MM)	D2 (MM)	Qty (Per Box) pcs	Weight (Per Pce) g
RD1-2573	2-7/8"	125	45	104	86	1	4,670.0
RD1-2575	2-15/16"	135	45	105	86	1	4,980.0
RD1-2576	3"	135	48	107	86	1	5,150.0
RD1-2579	3-1/8"	135	48	111	86	1	5,420.0
RD1-2584	3-1/4"	135	48	115	86	1	5,690.0
RD1-2585	3-3/8"	140	52	119	86	1	6,250.0
RD1-2588	3-1/2"	140	52	124	86	1	6,840.0
RD1-2591	3-5/8"	140	52	127	86	1	7,150.0
RD1-2594	3-3/4"	140	52	131	86	1	7,370.0
RD1-2597	3-7/8"	140	58	135	86	1	7,560.0
RD1-25100	4"	155	58	139	86	1	8,660.0
RD1-25103	4-1/8"	155	58	143	95	1	9,610.0
RD1-25106	4-1/4"	155	60	147	95	1	10,760.0
RD1-25113	4-1/2"	155	62	154	95	1	11,810.0

► 1" Dr Hexagon Semi-Deep Sockets

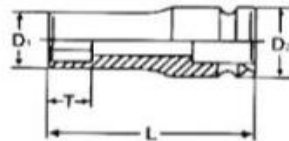

Stock Code	Size	L (MM)	T (MM)	D1 (MM)	D2 (MM)	Qty (Per Box) pcs	Weight (Per Pce) g
PD-2527	27mm	80	26	42	51	6	680.0
PD-2530	30mm	80	26	45	51	6	690.0
PD-2532	32mm	80	30	48	52	6	700.0
PD-2533	33mm	80	30	52	52	6	790.0
PD-2535	35mm	80	30	52	52	6	820.0
PD-2536	36mm	80	44	54	52	6	840.0
PD-2538	38mm	80	44	56	52	6	860.0
PD-2541	41mm	80	25	58	52	6	870.0



WARNING!

Wear safety goggles at all time. [User and bystanders]. Do not use chrome or handtools with power wrenches. Use only impact sockets and accessories with power impact wrenches.



IMPACT SOCKETS

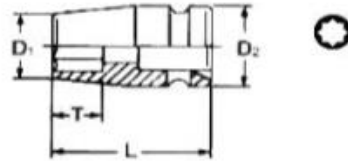

► 1"Dr Double Square (8 Point) Impact Regular Sockets - MM

Stock Code	Size	L (MM)	T (MM)	D1 (MM)	D2 (MM)	Qty (Per Box) pcs	Weight (Per Pce) g
DSM-2519	19mm	58	16	47	54	6	850.0
DSM-2524	24mm	58	16	52	54	6	918.0
DSM-2527	27mm	68	30	58	54	6	935.0
DSM-2530	30mm	70	32	61	54	6	950.0
DSM-2532	32mm	70	32	61	54	6	960.0
DSM-2535	35 mm	70	32	66	58	6	980.0
DSM-2538	38mm	70	32	73	58	6	1,000.0
DSM-2546	46mm	80	42	86	62	6	1,285.0
DS-2519	3/4"	58	16	47	54	6	855.0
DS-2520	13/16"	58	16	49	54	6	900.0
DS-2522	7/8"	58	16	51	54	6	905.0
DS-2524	15/16"	58	16	52	54	6	918.0
DS-2525	1"	58	16	54	54	6	925.0
DS-2527	1-1/16"	68	30	58	54	6	935.0
DS-2529	1-1/8"	68	30	58	54	6	945.0
DS-2530	1-3/16"	70	32	61	54	6	950.0
DS-2531	1-1/4"	70	32	61	54	6	960.0
DS-2533	1-5/16"	70	32	65	54	6	965.0
DS-2535	1-3/8"	70	32	67	58	6	980.0
DS-2536	1-7/16"	70	32	68	58	6	988.0
DS-2538	1-1/2"	70	32	73	58	6	1,000.0
DS-2541	1-5/8"	76	38	78	58	6	1,025.0
DS-2543	1-11/16"	78	40	84	62	6	1,075.0
DS-2544	1-3/4"	78	40	84	62	6	1,125.0
DS-2546	1-13/16"	80	42	86	62	6	1,149.0
DS-2548	1-7/8"	85	47	88	62	6	1,175.0
DS-2551	2"	85	47	92	62	6	1,205.0



www.promaxusa.com



WARNING!

Wear safety goggles at all time. [User and bystanders]. Do not use chrome or handtools with power wrenches. Use only impact sockets and accessories with power impact wrenches.

IMPACT SOCKETS

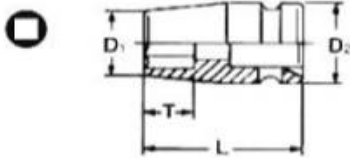

► 1"Dr Square Budd Wheel Deep Sockets

Stock Code	Size	L (MM)	T (MM)	D1 (MM)	D2 (MM)	Qty (Per Box) pcs	Weight (Per Pce) g
SDD-2517	17mm	76	16	40	52	6	640.0
SDD-2519	19mm	76	16	43	52	6	672.0
SDD-2520	20mm	76	16	44	52	6	710.0
SDD-2521	21mm	76	16	44	52	6	810.0

► 1"Dr Square Budd Wheel Deep With Double Opening

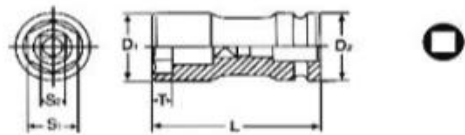

Stock Code	Size	S1 (MM)	S2 (MM)	L (MM)	T (MM)	D1 (MM)	D2 (MM)	Qty (Per Box) pcs	Weight (Per Pce) g
SSD-253517	35X17mm	35	17	95	13	54	52	6	980.0
SSD-253820	38X20mm	38	20	95	13	56	54	6	1,020.0
SSD-254121	41X21mm	41	21	100	14	58	54	6	1,060.0



WARNING!

Wear safety goggles at all time. (User and bystanders). Do not use chrome or handtools with power wrenches. Use only impact sockets and accessories with power impact wrenches.



IMPACT SOCKETS

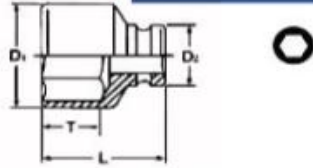

► 1-1/2" Dr Hexagon Regular Sockets

Stock Code	Size	L (MM)	T (MM)	D1 (MM)	D2 (MM)	Qty (Per Box) pcs	Weight (Per Pce) g
NE-38030	30mm	78	23	56	86	1	2,090.0
NE-38032	32mm	78	23	58	86	1	2,130.0
NE-38035	35mm	78	23	62	86	1	2,160.0
NE-38036	36mm	78	23	64	86	1	2,200.0
NE-38037	37mm	78	23	65	86	1	2,240.0
NE-38038	38mm	78	24	66	86	1	2,280.0
NE-38040	40mm	78	24	68	86	1	2,320.0
NE-38041	41mm	80	26	70	86	1	2,370.0
NE-38042	42mm	80	26	71	86	1	2,450.0
NE-38045	45mm	84	27	75	86	1	2,520.0
NE-38046	46mm	84	27	76	86	1	2,590.0
NE-38047	47mm	84	29	77	86	1	2,660.0
NE-38048	48mm	84	29	79	86	1	2,720.0
NE-38050	50mm	87	29	81	86	1	2,800.0
NE-38052	52mm	87	31	83	86	1	2,860.0
NE-38054	54mm	90	36	86	86	1	2,920.0
NE-38055	55mm	90	36	86	86	1	2,980.0
NE-38056	56mm	92	38	86	86	1	3,050.0
NE-38058	58mm	92	38	92	86	1	3,120.0
NE-38060	60mm	92	38	93	86	1	3,200.0
NE-38061	61mm	95	40	95	86	1	3,420.0
NE-38062	62mm	95	40	96	86	1	3,640.0
NE-38065	65mm	95	40	97	86	1	3,860.0
NE-38068	68mm	100	43	104	86	1	4,080.0
NE-38070	70mm	100	43	105	86	1	4,300.0
NE-38072	72mm	103	45	108	86	1	4,570.0
NE-38075	75mm	103	45	110	86	1	4,850.0
NE-38078	78mm	110	50	115	86	1	5,120.0
NE-38080	80mm	110	50	116	86	1	5,400.0
NE-38085	85mm	118	55	125	86	1	5,795.0
NE-38088	88mm	118	55	128	86	1	6,185.0
NE-38090	90mm	118	55	130	86	1	6,310.0
NE-38095	95mm	118	55	137	95	1	6,980.0



www.promaxusa.com



WARNING!

Wear safety goggles at all time. [User and bystanders]. Do not use chrome or handtools with power wrenches. Use only impact sockets and accessories with power impact wrenches.

► 1-1/2" Dr Hexagon Regular Sockets

Stock Code	Size	L (MM)	T (MM)	D1 (MM)	D2 (MM)	Qty (Per Box) pcs	Weight (Per Pce) g
NE-38100	100mm	125	58	140	95	1	8,060.0
NE-38105	105mm	125	58	150	95	1	9,120.0
NE-38110	110mm	125	58	156	95	1	10,250.0
NE-38115	115mm	135	65	160	95	1	10,540.0
NE-38120	120mm	135	65	168	95	1	10,610.0
NE-38125	125mm	135	65	175	95	1	13,000.0
OE-38030	1-3/16"	78	23	56	86	1	1,950.0
OE-38031	1-1/4"	78	23	58	86	1	1,960.0
OE-38033	1-5/16"	78	23	60	86	1	2,010.0
OE-38035	1-3/8"	78	23	62	86	1	2,190.0
OE-38036	1-7/16"	78	23	64	86	1	2,195.0
OE-38038	1-1/2"	78	24	66	86	1	2,200.0
OE-38039	1-9/16"	78	24	68	86	1	2,230.0
OE-38041	1-5/8"	80	26	70	86	1	2,340.0
OE-38043	1-11/16"	80	26	71	86	1	2,430.0
OE-38044	1-3/4"	84	27	75	86	1	2,510.0
OE-38046	1-13/16"	84	27	76	86	1	2,550.0
OE-38048	1-7/8"	84	29	78	86	1	2,570.0
OE-38049	1-15/16"	87	29	80	86	1	2,595.0
OE-38050	2"	87	29	82	86	1	2,610.0
OE-38052	2-1/16"	87	30	83	86	1	2,640.0
OE-38054	2-1/8"	90	36	86	86	1	2,670.0
OE-38055	2-3/16"	90	36	86	86	1	2,690.0
OE-38057	2-1/4"	92	38	86	86	1	2,840.0
OE-38059	2-5/16"	92	38	92	86	1	2,990.0
OE-38060	2-3/8"	92	38	93	86	1	3,040.0
OE-38062	2-7/16"	95	40	96	86	1	3,070.0
OE-38063	2-1/2"	95	40	97	86	1	3,090.0
OE-38065	2-9/16"	95	40	97	86	1	3,490.0
OE-38067	2-5/8"	100	43	103	86	1	3,730.0
OE-38068	2-11/16"	100	43	104	86	1	3,810.0
OE-38070	2-3/4"	100	43	105	86	1	3,980.0
OE-38072	2-13/16"	103	45	108	86	1	4,010.0
OE-38073	2-7/8"	103	45	108	86	1	4,290.0
OE-38074	2-15/16"	103	45	110	86	1	4,440.0
OE-38075	3"	103	45	110	86	1	4,530.0
OE-38077	3-1/16"	110	50	115	86	1	4,820.0
OE-38078	3-1/8"	110	50	116	86	1	5,090.0
OE-38080	3-3/16"	110	50	125	86	1	5,200.0
OE-38081	3-1/4"	110	50	125	86	1	5,320.0
OE-38083	3-5/16"	118	55	125	86	1	5,690.0
OE-38085	3-3/8"	118	55	125	86	1	5,730.0



WARNING!

Wear safety goggles at all time. [User and bystanders]. Do not use chrome or handtools with power wrenches
Use only impact sockets and accessories with power impact wrenches

► 1-1/2" Dr Hexagon Regular Sockets

Stock Code	Size	L (MM)	T (MM)	D1 (MM)	D2 (MM)	Qty (Per Box) pcs	Weight (Per Pce) g
OE-38086	3-7/16"	118	55	128	86	1	5,940.0
OE-38088	3-1/2"	118	55	130	86	1	6,190.0
OE-38089	3-9/16"	118	55	130	86	1	6,380.0
OE-38091	3-5/8"	118	55	130	86	1	6,510.0
OE-38092	3-11/16"	118	55	130	86	1	6,570.0
OE-38094	3-3/4"	118	55	137	95	1	6,980.0
OE-38095	3-13/16"	125	58	140	95	1	7,040.0
OE-38097	3-7/8"	125	58	140	95	1	8,320.0
OE-38098	3-15/16"	125	58	140	95	1	8,370.0
OE-38100	4"	125	58	140	95	1	8,440.0
OE-38102	4-1/16"	125	58	146	95	1	8,530.0
OE-38103	4-1/8"	125	58	150	95	1	9,110.0
OE-38105	4-3/16"	125	58	150	95	1	9,230.0
OE-38106	4-1/4"	125	58	150	95	1	9,350.0
OE-38108	4-5/16"	125	58	156	95	1	9,430.0
OE-38109	4-3/8"	125	58	160	95	1	9,570.0
OE-38111	4-7/16"	125	58	160	95	1	9,680.0
OE-38113	4-1/2"	135	65	160	95	1	10,500.0
OE-38115	4-5/8"	135	65	165	95	1	10,220.0
OE-38119	4-3/4"	135	65	168	95	1	10,370.0
OE-38122	4-7/8"	135	68	177	98	1	11,900.0
OE-38125	5"	135	68	177	98	1	13,800.0

► 1-1/2" Dr Hexagon Deep Sockets

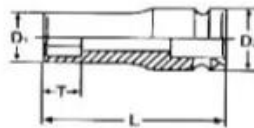
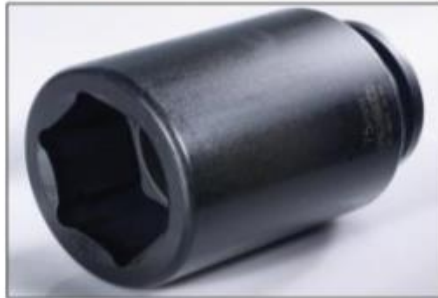

Stock Code	Size	L (MM)	T (MM)	D1 (MM)	D2 (MM)	Qty (Per Box) pcs	Weight (Per Pce) g
QE-38041	41mm	115	30	72	86	1	2,900.0
QE-38042	42mm	115	32	72	86	1	3,200.0
QE-38046	46mm	115	34	78	86	1	3,550.0
QE-38050	50mm	135	34	81	86	1	3,730.0
QE-38054	54mm	140	37	86	86	1	3,850.0
QE-38055	55mm	140	37	86	86	1	4,010.0



www.promaxusa.com



WARNING!

Wear safety goggles at all time. [User and bystanders]. Do not use chrome or handtools with power wrenches. Use only impact sockets and accessories with power impact wrenches.

IMPACT SOCKETS

▶ 1-1/2" Dr Hexagon Deep Sockets

Stock Code	Size	L (MM)	T (MM)	D1 (MM)	D2 (MM)	Qty (Per Box) pcs	Weight (Per Pce) g
QE-38060	60mm	150	40	94	86	1	5,060.0
QE-38063	63mm	150	43	97	86	1	5,750.0
QE-38065	65mm	150	45	100	86	1	6,010.0
QE-38070	70mm	160	48	106	86	1	6,390.0
QE-38075	75mm	170	50	112	86	1	7,330.0
QE-38077	77mm	170	52	115	86	1	7,850.0
QE-38080	80mm	170	54	118	86	1	8,140.0
QE-38085	85mm	170	58	125	86	1	8,230.0
QE-38090	90mm	170	60	131	86	1	9,510.0
QE-38095	95mm	180	62	138	95	1	10,700.0
QE-38100	100mm	185	70	140	95	1	12,400.0
QE-38105	105mm	195	70	150	95	1	13,800.0
QE-38110	110mm	195	90	156	95	1	15,400.0
QE-380115	115mm	195	90	160	95	1	17,000.0
QE-380120	120mm	205	90	168	95	1	18,500.0
RE-38041	1-5/8"	115	30	72	86	1	2,950.0
RE-38043	1-11/16"	115	34	74	86	1	3,280.0
RE-38044	1-3/4"	115	34	75	86	1	3,350.0
RE-38046	1-13/16"	115	34	78	86	1	3,590.0
RE-38048	1-7/8"	115	36	80	86	1	3,700.0
RE-38049	1-15/16"	115	36	81	86	1	3,880.0
RE-38051	2"	135	36	83	86	1	4,010.0
RE-38052	2-1/16"	140	39	84	86	1	4,270.0
RE-38054	2-1/8"	140	39	86	86	1	4,360.0
RE-38056	2-3/16"	140	39	88	86	1	4,900.0
RE-38057	2-1/4"	150	41	90	86	1	5,000.0
RE-38059	2-5/16"	150	41	92	86	1	5,180.0
RE-38060	2-3/8"	150	43	94	86	1	5,400.0
RE-38062	2-7/16"	150	43	96	86	1	5,500.0
RE-38063	2-1/2"	150	43	98	86	1	5,850.0
RE-38065	2-9/16"	150	45	100	86	1	6,290.0
RE-38067	2-5/8"	150	47	102	86	1	6,400.0
RE-38068	2-11/16"	150	47	104	86	1	6,510.0
RE-38070	2-3/4"	160	47	106	86	1	6,780.0
RE-38072	2-13/16"	160	49	108	86	1	6,881.0
RE-38073	2-7/8"	160	49	109	86	1	7,040.0
RE-38075	2-15/16"	170	51	112	86	1	7,200.0



WARNING!

Wear safety goggles at all time. [User and bystanders]. Do not use chrome or handtools with power wrenches. Use only impact sockets and accessories with power impact wrenches.



IMPACT SOCKETS

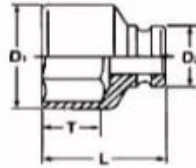

► 2-1/2" Dr Hexagon Regular Sockets

Stock Code	Size	L (MM)	T (MM)	D1 (MM)	D2 (MM)	Qty (Per Box) pcs	Weight (Per Pce) g
NG-63070	70mm	130	43	110	127	1	7,150.0
NG-63075	75mm	140	43	118	127	1	8,010.0
NG-63077	77mm	140	48	122	127	1	8,120.0
NG-63080	80mm	140	48	124	127	1	8,230.0
NG-63085	85mm	140	48	130	127	1	8,260.0
NG-63090	90mm	145	54	136	127	1	9,270.0
NG-63095	95mm	145	54	143	127	1	9,770.0
NG-63100	100mm	150	57	147	127	1	10,340.0
NG-63105	105mm	155	61	155	127	1	11,620.0
NG-63110	110mm	160	64	161	127	1	12,770.0
NG-63115	115mm	165	65	167	127	1	13,780.0
NG-63120	120mm	170	71	176	127	1	15,210.0
NG-63125	125mm	175	75	181	127	1	17,060.0
NG-63130	130mm	175	75	188	127	1	19,530.0
NG-63135	135mm	180	79	195	127	1	21,120.0
NG-63140	140mm	180	79	202	127	1	20,250.0
NG-63145	145mm	185	83	208	127	1	23,720.0
NG-63150	150mm	185	87	215	127	1	26,050.0
NG-63155	155mm	190	91	223	127	1	27,850.0
NG-63160	160mm	190	91	227	127	1	29,200.0
NG-63165	165mm	195	95	235	127	1	30,500.0
NG-63170	170mm	195	100	241	127	1	31,850.0
NG-63175	175mm	200	105	248	127	1	33,200.0
NG-63180	180mm	200	105	254	127	1	34,500.0
NG-63185	185mm	210	110	258	152	1	36,500.0
NG-63190	190mm	210	110	265	152	1	38,800.0
NG-63200	200mm	220	115	275	152	1	43,000.0
OG-63075	3"	140	48	120	127	1	7,970.0
OG-63078	3-1/8"	140	51	124	127	1	8,130.0
OG-63081	3-1/4"	140	51	127	127	1	8,320.0
OG-63085	3-3/8"	140	51	131	127	1	8,440.0
OG-63088	3-1/2"	140	51	135	127	1	8,840.0



www.promaxusa.com



WARNING!

Wear safety goggles at all time. [User and bystanders]. Do not use chrome or handtools with power wrenches. Use only impact sockets and accessories with power impact wrenches.

IMPACT SOCKETS

▶ 2-1/2" Dr Hexagon Regular Sockets

Stock Code	Size	L (MM)	T (MM)	D1 (MM)	D2 (MM)	Qty (Per Box) pcs	Weight (Per Pce) g
OG-63091	3-5/8"	145	54	139	127	1	9,360.0
OG-63094	3-3/4"	145	54	143	127	1	9,680.0
OG-63097	3-7/8"	150	58	147	127	1	10,580.0
OG-63100	4"	150	58	151	127	1	10,670.0
OG-63103	4-1/8"	155	61	155	127	1	11,350.0
OG-63106	4-1/4"	160	64	159	127	1	12,410.0
OG-63111	4-3/8"	165	67	163	127	1	12,800.0
OG-63113	4-1/2"	165	67	167	127	1	13,820.0
OG-63116	4-5/8"	170	71	172	127	1	15,100.0
OG-63119	4-3/4"	170	71	176	127	1	15,340.0
OG-63122	4-7/8"	175	75	181	127	1	15,710.0
OG-63125	5"	175	75	185	127	1	16,830.0
OG-63128	5-1/8"	175	75	188	127	1	19,570.0
OG-63131	5-1/4"	175	75	193	127	1	20,320.0
OG-63135	5-3/8"	180	79	197	127	1	21,790.0
OG-63138	5-1/2"	180	79	202	127	1	23,200.0
OG-63141	5-5/8"	185	83	206	127	1	24,100.0
OG-63144	5-3/4"	185	83	210	127	1	25,000.0
OG-63147	5-7/8"	185	87	215	127	1	25,300.0
OG-63150	6"	185	87	218	127	1	27,000.0
OG-63153	6-1/8"	190	91	223	127	1	28,600.0
OG-63156	6-1/4"	190	91	227	127	1	28,950.0
OG-63160	6-3/8"	195	95	231	127	1	29,800.0
OG-63163	6-1/2"	195	95	235	127	1	31,200.0
OG-63166	6-5/8"	195	100	240	127	1	31,500.0
OG-63169	6-3/4"	195	100	244	127	1	32,100.0
OG-63172	6-7/8"	200	105	248	127	1	32,800.0
OG-63175	7"	200	105	252	127	1	33,500.0



WARNING!

Wear safety goggles at all time. [User and bystanders]. Do not use chrome or handtools with power wrenches
Use only impact sockets and accessories with power impact wrenches



IMPACT ACCESSORIES

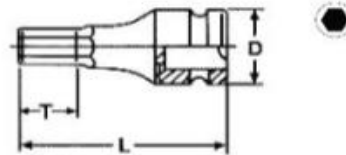

► Hex Allen Key Sockets

Stock Code	Sq. Drive	Size	L (MM)	T (MM)	D (MM)	Qty (Per Box) pcs	Weight (Per Pce) g
TH1-1204	1/2"	4mm	76	20	25	12	80.0
TH1-1205	1/2"	5mm	76	20	25	12	85.0
TH1-1206	1/2"	6mm	76	20	25	12	90.0
TH1-1207	1/2"	7mm	76	20	25	12	95.0
TH1-1208	1/2"	8mm	76	25	25	12	100.0
TH1-1209	1/2"	9mm	76	25	25	12	105.0
TH1-1210	1/2"	10mm	76	25	25	12	110.0
TH1-1211	1/2"	11mm	76	25	25	12	125.0
TH1-1212	1/2"	12mm	76	25	25	6	130.0
TH1-1213	1/2"	13mm	76	25	25	6	138.0
TH1-1214	1/2"	14mm	76	25	25	6	148.0
TH1-1215	1/2"	15mm	76	25	25	6	160.0
TH1-1216	1/2"	16mm	76	25	25	6	170.0
TH1-1217	1/2"	17mm	76	25	25	6	180.0
TH1-1218	1/2"	18mm	76	25	25	6	195.0
TH1-1219	1/2"	19mm	76	25	25	6	210.0
TH2-1204	1/2"	3/16"	76	20	25	12	82.0
TH2-1205	1/2"	7/32"	76	20	25	12	87.0
TH2-1206	1/2"	1/4"	76	20	25	12	90.0
TH2-1207	1/2"	9/32"	76	20	25	12	95.0
TH2-1208	1/2"	5/16"	76	25	25	12	98.0
TH2-1210	1/2"	3/8"	76	25	25	12	105.0
TH2-1211	1/2"	7/16"	76	25	25	12	128.0
TH2-1213	1/2"	1/2"	76	25	25	6	134.0
TH2-1214	1/2"	9/16"	76	25	25	6	150.0
TH2-1216	1/2"	5/8"	76	25	25	6	170.0
TH2-1217	1/2"	11/16"	76	25	25	6	185.0
TH2-1219	1/2"	3/4"	76	25	25	6	208.0



WARNING!

Wear safety goggles at all time. [User and bystanders]. Do not use chrome or handtools with power wrenches. Use only impact sockets and accessories with power impact wrenches.

IMPACT ACCESSORIES

▶ Hex Allen Key Sockets

Stock Code	Sq. Drive	Size	L (MM)	T (MM)	D (MM)	Qty (Per Box) pcs	Weight (Per Pce) g
TT1-1910	3/4"	10mm	100	20	44	6	470.0
TT1-1912	3/4"	12mm	100	20	44	6	480.0
TT1-1914	3/4"	14mm	100	20	44	6	490.0
TT1-1917	3/4"	17mm	100	20	44	6	560.0
TT1-1919	3/4"	19mm	100	20	44	6	580.0
TT1-1922	3/4"	22mm	100	20	44	6	620.0
TT1-1924	3/4"	24mm	100	20	44	6	670.0
TT1-1927	3/4"	27mm	100	20	44	6	750.0
TT1-1928	3/4"	28mm	100	20	44	6	770.0
TT1-1929	3/4"	29mm	100	20	44	6	780.0
TT1-1930	3/4"	30mm	100	20	44	6	800.0
TT1-1932	3/4"	32mm	100	20	44	6	890.0
TT1-1933	3/4"	33mm	100	20	44	6	1,050.0
TT1-1934	3/4"	34mm	100	20	44	6	1,120.0
TT1-1935	3/4"	35mm	100	20	44	6	1,150.0
TT1-1936	3/4"	36mm	100	20	44	6	1,180.0
TT1-1938	3/4"	38mm	100	20	44	6	1,240.0
TT2-1910	3/4"	3/8"	100	20	44	6	470.0
TT2-1911	3/4"	7/16"	100	20	44	6	480.0
TT2-1913	3/4"	1/2"	100	20	44	6	490.0
TT2-1914	3/4"	9/16"	100	20	44	6	510.0
TT2-1916	3/4"	5/8"	100	20	44	6	530.0
TT2-1917	3/4"	11/16"	100	20	44	6	540.0
TT2-1919	3/4"	3/4"	100	20	44	6	580.0
TT2-1920	3/4"	13/16"	100	20	44	6	590.0
TT2-1922	3/4"	7/8"	100	20	44	6	610.0
TT2-1924	3/4"	15/16"	100	20	44	6	665.0
TT2-1925	3/4"	1"	100	20	44	6	720.0
TT2-1927	3/4"	1-1/16"	100	20	44	6	750.0
TT2-1929	3/4"	1-1/8"	100	20	44	6	810.0
TT2-1930	3/4"	1-3/16"	100	20	44	6	870.0
TT2-1931	3/4"	1-1/4"	100	20	44	6	930.0
TT2-1933	3/4"	1-5/16"	100	20	44	6	980.0
TT2-1935	3/4"	1-3/8"	100	20	44	6	1,030.0
TT2-1936	3/4"	1-7/16"	100	20	44	6	1,190.0
TT2-1938	3/4"	1-1/2"	100	20	44	6	1,220.0



WARNING!

Wear safety goggles at all time. [User and bystanders]. Do not use chrome or handtools with power wrenches. Use only impact sockets and accessories with power impact wrenches.

IMPACT ACCESSORIES

► Hex Allen Key Sockets

Stock Code	Sq. Drive	Size	L (MM)	T (MM)	D (MM)	Qty (Per Box) pcs	Weight (Per Pce) g
TD1-2510	1"	10mm	100	20	54	6	770.0
TD1-2512	1"	12mm	100	20	54	6	780.0
TD1-2514	1"	14mm	100	20	54	6	790.0
TD1-2517	1"	17mm	100	20	54	6	810.0
TD1-2519	1"	19mm	100	20	54	6	860.0
TD1-2522	1"	22mm	100	20	54	6	870.0
TD1-2524	1"	24mm	100	20	54	6	930.0
TD1-2527	1"	27mm	100	20	54	6	990.0
TD1-2528	1"	28mm	10	20	54	6	1,010.0
TD1-2530	1"	30mm	10	20	54	6	1,030.0
TD1-2532	1"	32mm	10	20	54	6	1,120.0
TD1-2533	1"	33mm	10	20	54	6	1,160.0
TD1-2536	1"	36mm	10	20	54	6	1,190.0
TD1-2538	1"	38mm	10	20	54	6	1,290.0
TD1-2541	1"	41mm	10	20	54	6	1,360.0
TD1-2546	1"	46mm	10	20	54	6	2,000.0
TD2-2513	1"	1/2"	100	20	54	6	770.0
TD2-2514	1"	9/16"	100	20	54	6	780.0
TD2-2516	1"	5/8"	100	20	54	6	790.0
TD2-2519	1"	3/4"	100	20	54	6	840.0
TD2-2520	1"	13/16"	100	20	54	6	860.0
TD2-2522	1"	7/8"	100	20	54	6	870.0
TD2-2525	1"	1"	100	20	54	6	880.0
TD2-2527	1"	1-1/16"	100	20	54	6	1000.0
TD2-2529	1"	1-1/8"	100	20	54	6	1020.0
TD2-2530	1"	1-3/16"	100	20	54	6	1050.0
TD2-2531	1"	1-1/4"	100	20	54	6	1225.0
TD2-2533	1"	1-5/16"	100	20	54	6	1278.0
TD2-2535	1"	1-3/8"	100	20	54	6	1285.0
TD2-2538	1"	1-1/2"	100	20	54	6	1375.0
TD2-2541	1"	1-5/8"	100	20	54	6	1480.0
TD2-2544	1"	1-3/4"	100	20	54	6	1800.0
TD2-2546	1"	1-13/16"	100	20	54	6	2150.0
TE1-3819	1-1/2"	19mm	120	20	86	1	1,700.00
TE1-3822	1-1/2"	22mm	120	20	86	1	1,850.00



WARNING!

Wear safety goggles at all time. [User and bystanders]. Do not use chrome or handtools with power wrenches. Use only impact sockets and accessories with power impact wrenches.

IMPACT ACCESSORIES

► Hex Allen Key Sockets

Stock Code	Sq. Drive	Size	L (MM)	T (MM)	D (MM)	Qty (Per Box) pcs	Weight (Per Pce) g
TE1-3824	1-1/2"	24mm	120	20	86	1	1,970.00
TE1-3827	1-1/2"	27mm	120	20	86	1	2,100.00
TE1-3830	1-1/2"	30mm	120	20	86	1	2,250.00
TE1-3832	1-1/2"	32mm	120	20	86	1	2,380.00
TE1-3833	1-1/2"	33mm	120	20	86	1	2,500.00
TE1-3836	1-1/2"	36mm	120	20	86	1	2,650.00
TE1-3838	1-1/2"	38mm	120	20	86	1	2,800.00
TE1-3841	1-1/2"	41mm	120	20	86	1	3,000.00
TE1-3846	1-1/2"	46mm	120	20	86	1	3,140.00
TE1-3850	1-1/2"	50mm	120	20	86	1	3,320.00
TE1-3855	1-1/2"	55mm	120	20	86	1	3,580.00
TE2-3819	1-1/2"	3/4"	120	20	86	1	1,720.00
TE2-3820	1-1/2"	13/16"	120	20	86	1	1,800.00
TE2-3822	1-1/2"	7/8"	120	20	86	1	1,880.00
TE2-3824	1-1/2"	15/16"	120	20	86	1	1,950.00
TE2-3825	1-1/2"	1"	120	20	86	1	2,020.00
TE2-3827	1-1/2"	1-1/16"	120	20	86	1	2,150.00
TE2-3829	1-1/2"	1-1/8"	120	20	86	1	2,200.00
TE2-3830	1-1/2"	1-3/16"	120	20	86	1	2,300.00
TE2-3831	1-1/2"	1-1/4"	120	20	86	1	2,320.00
TE2-3833	1-1/2"	1-5/16"	120	20	86	1	2,530.00
TE2-3835	1-1/2"	1-3/8"	120	20	86	1	2,620.00
TE2-3838	1-1/2"	1-1/2"	120	20	86	1	2,720.00
TE2-3841	1-1/2"	1-5/8"	120	20	86	1	2,790.00
TE2-3844	1-1/2"	1-3/4"	120	20	86	1	2,820.00
TE2-3846	1-1/2"	1-13/16"	120	20	86	1	2,860.00
TE2-3851	1-1/2"	2"	120	20	86	1	3,020.00
TE2-3854	1-1/2"	2-1/8"	120	20	86	1	3,140.00
TE2-3856	1-1/2"	2-3/16"	120	20	86	1	3,200.00



WARNING!

Wear safety goggles at all time. [User and bystanders]. Do not use chrome or handtools with power wrenches. Use only impact sockets and accessories with power impact wrenches.



IMPACT ACCESSORIES



L-Handle

Stock Code	Sq. Dr.	L (MM)	D (MM)	Qty (Per Box) pcs	Weight (Per Pce) g
A1-19315	3/4"	450	25	12	1,950.0
A2-25600	1"	550	34	6	5,110.0

Adaptor

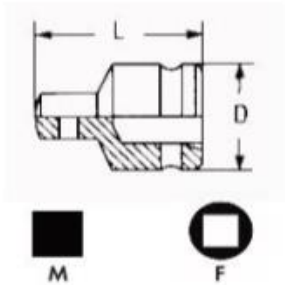

Stock Code	F	M	L (MM)	D (MM)	Qty (Per Box) pcs	Weight (Per Pce) g
AA-09/2	3/8"F	1/2"M	36	22	12	60.0
AB-12/1	1/2"F	3/8"M	38	25	12	70.0
AB-12/3	1/2"F	3/4"M	48	30	6	165.0
AC-19/2	3/4"F	1/2"M	56	44	12	310.0
AC-19/3	3/4"F	1"M	63	44	12	450.0
AD-25/1	1"F	3/4"M	76	54	6	670.0
AD-25/2	1"F	1-1/2"M	90	54	6	1,130.0
AE-37/1	1-1/2"F	1"M	100	86	1	2,160.0
AE-38/4	1-1/2"F	2-1/2"M	120	86	1	4,030.0
AG-63/2	2-1/2"F	1-1/2"M	138	127	1	7,150.0



WARNING!

Wear safety goggles at all time. [User and bystanders]. Do not use chrome or handtools with power wrenches. Use only impact sockets and accessories with power impact wrenches.

IMPACT ACCESSORIES

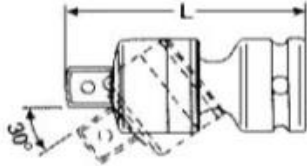

► Universal Joint

Stock Code	Sq. Drive	L (MM)	Qty (Per Box) pcs	Weight (Per Pce) g
BA-1075	3/8"	50	6	110.0
BB-12075	1/2"	60	3	210.0
BC-19105	3/4"	105	6	520.0
BD-25133	1"	133	6	1,050.0
BE-38182	1-1/2"	182	1	4,270.0

► Sliding T-Handle

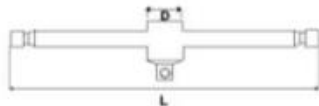

Stock Code	Sq. Dr.	L (MM)	D (MM)	Qty (Per Box) pcs	Weight (Per Pce) g
CD-12300	1/2"	300	24	12	510.0
CD-19480	3/4"	500	37	12	1,600.0
CD-25640	1"	750	49	6	4,350.0



WARNING!

Wear safety goggles at all time. [User and bystanders]. Do not use chrome or handtools with power wrenches. Use only impact sockets and accessories with power impact wrenches.



IMPACT ACCESSORIES

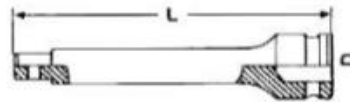

► Extension Bar

Stock Code	Sq. Dr.	L (MM)	D (MM)	Qty (Per Box) pcs	Weight (Per Pce) g
EA-10125	3/8"	125mm	19	12	130.0
EA-10250	3/8"	250mm	19	12	260.0
EB-12075	1/2"	75mm	25	6	150.0
EB-12100	1/2"	100mm	25	12	185.0
EB-12125	1/2"	125mm	25	12	230.0
EB-12150	1/2"	150mm	25	12	270.0
EB-12200	1/2"	200mm	25	12	350.0
EB-12250	1/2"	250mm	25	12	430.0
EC-19075	3/4"	75mm	44	6	480.0
EC-19100	3/4"	100mm	44	6	635.0
EC-19125	3/4"	125mm	44	6	720.0
EC-19150	3/4"	150mm	44	6	810.0
EC-19175	3/4"	175mm	44	6	870.0
EC-19200	3/4"	200mm	44	6	970.0
EC-19250	3/4"	250mm	44	4	1,160.0
EC-19300	3/4"	300mm	44	4	1,370.0
EC-19330	3/4"	330mm	44	4	1,470.0
EC-19400	3/4"	400mm	44	4	1,740.0
ED-25150	1"	150mm	54	5	1,320.0
ED-25175	1"	175mm	54	4	1,480.0
ED-25200	1"	200mm	54	3	1,660.0
ED-25250	1"	250mm	54	3	2,010.0
ED-25300	1"	300mm	54	3	2,050.0
ED-25330	1"	330mm	54	2	2,550.0
ED-25400	1"	400mm	54	1	3,040.0
EE-38125	1-1/2"	125mm	86	1	3,390.0
EE-38250	1-1/2"	250mm	86	1	5,620.0
EE-38300	1-1/2"	300mm	86	1	6,390.0
EE-38500	1-1/2"	500mm	86	1	9,550.0
EG-63125	2-1/2"	125mm	127	1	10,500.0
EG-63250	2-1/2"	250mm	127	1	14,800.0
EG-63500	2-1/2"	500mm	127	1	19,800.0



www.promaxusa.com



WARNING!

Wear safety goggles at all time. [User and bystanders]. Do not use chrome or handtools with power wrenches. Use only impact sockets and accessories with power impact wrenches.

IMPACT ACCESSORIES

► Pry Bar / Tyre Levers



Stock Code	L (MM)	Qty (Per Box) pcs	Weight (Per Pce) g
FF-0400	400mm	24	750.0
FF-0450	450mm	24	800.0



Stock Code	L (MM)	Qty (Per Box) pcs	Weight (Per Pce) g
FF-0600	600mm	12	1,800.0



Stock Code	L (MM)	Qty (Per Box) pcs	Weight (Per Pce) g
TL-0600	600mm	24	1,300.0



WARNING!

Wear safety goggles at all time. (User and bystanders). Do not use chrome or handtools with power wrenches.
Use only impact sockets and accessories with power impact wrenches.



WRENCHES



WRENCHES



► Combination Wrench - MM Size

Stock Code	Size	L (MM)	B (MM)	D (MM)	S1 (MM)	S2 (MM)	Qty (Per Box) pcs	Weight (Per Pce) g
PW-06110	6mm	109	14.4	10.3	3.7	5.2	12	22.0
PW-07120	7mm	119	16.2	11.3	3.8	5.2	12	23.0
PW-08130	8mm	129	18.6	12.8	4.2	5.7	12	31.2
PW-09140	9mm	139	20.7	14.1	4.3	6.4	12	41.1
PW-10150	10mm	149	22.6	15.2	4.8	6.9	12	46.0
PW-11160	11mm	159	24.6	16.8	5.2	7.4	12	53.3
PW-12170	12mm	169	27.1	18.0	5.3	7.9	12	68.5
PW-13180	13mm	179	28.7	19.8	6.0	8.6	12	84.3
PW-14190	14mm	189	31.3	20.8	6.2	8.9	12	104.8
PW-15200	15mm	199	33.2	22.3	6.6	9.2	12	119.0
PW-16210	16mm	209	35.0	23.8	6.8	9.9	12	137.1
PW-17220	17mm	219	37.5	25.0	7.0	10.9	12	168.5
PW-18230	18mm	229	39.5	26.6	7.8	11.4	12	185.8
PW-19240	19mm	239	41.3	28.0	8.0	12.1	12	194.7
PW-20250	20mm	249	44.1	29.8	8.3	12.4	12	220.7
PW-21260	21mm	259	46.1	30.8	8.6	12.7	12	251.7
PW-22270	22mm	269	48.2	32.2	9.0	13.1	6	264.0
PW-23280	23mm	279	49.8	33.6	9.2	13.4	6	318.4
PW-24290	24mm	289	51.4	34.3	9.6	13.4	6	344.6
PW-25300	25mm	299	54.6	36.8	9.8	14.2	6	435.5
PW-26310	26mm	309	56.2	37.3	10.0	14.9	6	466.8
PW-27320	27mm	319	58.7	39.6	10.4	16.4	6	536.0
PW-28330	28mm	330	59.4	40.6	10.8	17.1	6	605.0
PW-29340	29mm	339	60.9	41.7	11.0	17.4	6	594.0
PW-30350	30mm	349	63.0	43.3	11.3	18.4	6	633.6
PW-32370	32mm	369	67.3	44.7	11.6	19.5	6	786.0
PW-33410	33mm	410	69.7	48.7	12.6	19.5	4	911.6
PW-34410	34mm	410	70.0	49.0	12.8	19.5	3	980.8
PW-35410	35mm	410	70.0	49.0	12.8	19.5	3	1,100.0
PW-36440	36mm	438.5	73.7	52.8	13.8	20.4	12	1,231.2
PW-38460	38mm	438.5	73.7	52.8	13.8	20.4	12	1,241.4
PW-40480	40mm	478	83.0	60.0	15.6	21.2	12	1,300.0



www.promaxusa.com



WARNING!

Wear safety goggles at all time. [User and bystanders]. Do not use chrome or handtools with power wrenches
Use only impact sockets and accessories with power impact wrenches

► Combination Wrench - MM Size

Stock Code	Size	L (MM)	B (MM)	D (MM)	S1 (MM)	S2 (MM)	Qty (Per Box) pcs	Weight (Per Pce) g
PW-41500	41mm	478.5	83.7	60.8	15.8	21.4	12	1,561.0
PW-43480	43mm	479	83.8	62.0	16.0	21.5	8	1,600.0
PW-45550	45mm	548	93.4	69.5	17.2	22.5	8	2,235.0
PW-46550	46mm	548.5	95.4	71.5	17.5	22.8	8	2,328.0
PW-50600	50mm	548.5	98.7	73.8	17.8	23.5	8	2,346.0
PW-55620	55mm	609	109.7	82.8	18.8	24.4	6	3,020.0
PW-60700	60mm	700	121.4	91.8	19.5	27.4	5	4,280.0
PW-65700	65mm	700	128.7	94.8	19.8	27.4	4	4,400.0
PW-70680	70mm	700	147.0	107.0	22.0	30.0	4	5,620.0
PW-75720	75mm	720	153.0	112.6	27.5	36.2	4	7,130.0
PW-80720	80mm	720	153.0	112.6	27.5	36.2	4	6,640.0
PWI-001411	1/4"	109	14.4	10.3	3.7	5.2	12	21.3
PWI-051613	5/16"	129	18.6	12.8	4.2	5.7	12	31.2
PWI-113214	11/32	139	20.8	14.0	4.1	6.6	12	29.0
PWI-003815	3/8"	149	22.6	15.2	4.8	6.9	12	46.0
PWI-071616	7/16"	159	24.6	16.8	5.2	7.4	12	53.3
PWI-001218	1/2"	179	28.7	19.8	6.0	8.6	12	84.3
PWI-091619	9/16"	189	31.3	20.8	6.2	8.9	12	104.8
PWI-005821	5/8"	209	35.0	23.8	6.8	9.9	12	137.1
PWI-111623	11/16"	219	37.5	25.0	7.0	10.9	12	168.5
PWI-003424	3/4"	239	41.3	28.0	8.0	12.1	12	216.0
PWI-131626	13/16"	259	46.1	30.8	8.6	12.7	12	260.0
PWI-007827	7/8"	269	48.2	32.2	9.0	13.1	6	287.0
PWI-151629	15/16"	289	51.4	34.3	9.6	13.4	6	360.0
PWI-000131	1"	299	54.6	36.8	9.8	14.2	6	435.5
PWI-111632	1-1/16"	319	58.7	39.6	10.4	16.4	6	536.0
PWI-011834	1-1/8"	339	60.9	41.7	11.0	17.4	6	594.0
PWI-011437	1-1/4"	369	67.3	44.8	11.8	19.4	6	815.0
PWI-015164	1-5/16"	409	69.8	48.7	12.6	19.5	4	911.6
PWI-001384	1-3/8"	409	69.8	48.7	12.6	19.5	12	1,030.0
PWI-017164	1-7/16"	439	73.8	52.7	13.6	20.5	12	1,180.8
PWI-011250	1-1/2"	439	74.0	53.0	13.8	21.0	12	1,120.0
PWI-001585	1-5/8"	479	83.8	60.7	15.6	21.5	10	1,364.0
PWI-111165	1-11/16"	479	83.8	60.7	15.6	21.5	8	1,581.8
PWI-001345	1-3/4"	549	93.5	69.5	17.2	22.5	8	2,235.0
PWI-113165	1-13/16"	549	93.5	69.5	17.2	22.5	8	2,187.8
PWI-001785	1-7/8"	549	98.8	73.7	17.5	22.5	8	2,259.7
PWI-000255	2"	549	98.8	73.7	17.5	22.5	8	2,300.0
PWI-002185	2-1/8"	609	109.8	82.7	18.5	24.5	6	2,860.0
PWI-002316	2-3/16"	609	109.8	82.7	18.5	24.5	6	2,815.0
PWI-002145	2-1/4"	609	109.8	82.7	18.5	24.5	1	2,757.8
PWI-002385	2-3/8"	699	121.5	91.5	19.5	27.5	1	4,029.0
PWI-002125	2-1/2"	699	128.8	94.7	19.5	27.5	1	4,180.6



WARNING!

Wear safety goggles at all time. [User and bystanders]. Do not use chrome or handtools with power wrenches
Use only impact sockets and accessories with power impact wrenches

WRENCHES

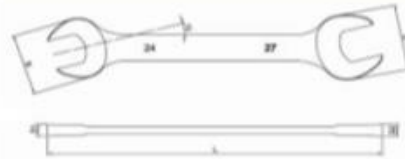

► Double Open End Wrench

Stock Code	Size	L (MM)	B (MM)	D (MM)	S1 (MM)	S2 (MM)	Qty (Per Box) pcs	Weight (Per Pce) g
PWO-0405	4 X 5mm	99	11.7	13.7	3.2	3.2	12	20.0
PWO-0607	6 X 7mm	127	14.2	17.5	3.4	3.4	12	26.0
PWO-0608	6 X 8mm	127	14.2	17.5	3.4	3.4	12	24.0
PWO-0708	7 X 8mm	145	18.1	21.3	3.7	3.7	12	34.5
PWO-0809	8 X 9mm	146	18.1	21.4	3.7	4.3	12	35.6
PWO-0810	8 X 10mm	146	18.1	21.3	4.2	4.2	12	40.0
PWO-0911	9 X 11mm	161	22.1	25.6	4.7	4.7	12	62.8
PWO-1011	10 X 11mm	162	22.1	25.7	4.7	4.7	12	55.0
PWO-1012	10 X 12mm	162	22.1	25.7	4.7	4.7	6	55.5
PWO-1013	10 X 13mm	174	26.5	30.2	5.3	5.2	6	89.2
PWO-1213	12 X 13mm	175	27.7	30.2	5.3	5.3	6	85.4
PWO-1214	12 X 14mm	175	27.7	30.1	5.3	5.2	6	87.5
PWO-1314	13 X 14mm	190	31.6	33.6	5.7	5.7	6	116.8
PWO-1315	13 X 15mm	190	31.6	33.6	5.7	5.7	6	117.0
PWO-1415	14 X 15mm	191	31.8	33.8	6.4	6.4	12	120.0
PWO-1417	14 X 17mm	194	31.8	38.1	6.2	6.2	12	126.7
PWO-1617	16 X 17mm	212	36.2	38.2	6.3	6.3	12	134.4
PWO-1719	17 X 19mm	223	40.1	42.1	6.7	6.7	12	177.8
PWO-1819	18 X 19mm	224	40.2	42.2	6.8	6.8	12	180.0
PWO-1921	19 X 21mm	236	44.1	48.1	7.5	7.5	12	215.9
PWO-1922	19 X 22mm	236	44.1	48.1	7.5	7.5	12	216.3
PWO-2021	20 X 21mm	236	44.1	48.1	7.5	7.5	12	217.0
PWO-2022	20 X 22mm	237	44.2	48.2	7.5	7.5	12	220.0
PWO-2123	21 X 23mm	246	46.1	50.1	7.7	7.7	12	288.0
PWO-2224	22 X 24mm	246	46.1	50.1	7.8	7.8	6	289.0
PWO-2326	23 X 26mm	267	53.1	57.6	8.4	8.4	6	371.3
PWO-2425	24 X 25mm	267	53.1	57.6	8.4	8.4	6	373.0
PWO-2426	24 X 26mm	267	53.1	57.6	8.4	8.4	6	375.0
PWO-2427	24 X 27mm	268	53.2	57.7	8.4	8.4	6	389.0
PWO-2528	25 X 28mm	268	53.2	57.7	8.4	8.4	6	393.0



www.promaxusa.com



WARNING!

Wear safety goggles at all time. [User and bystanders]. Do not use chrome or handtools with power wrenches. Use only impact sockets and accessories with power impact wrenches.

WRENCHES

► Double Open End Wrench

Stock Code	Size	L (MM)	B (MM)	D (MM)	S1 (MM)	S2 (MM)	Qty (Per Box) pcs	Weight (Per Pce) g
PWO-2627	26 X 27mm	267	53.1	57.6	8.4	8.4	6	412.0
PWO-2729	27 X 29mm	284	58.6	62.1	8.7	8.7	6	432.2
PWO-2829	28 X 29mm	284	58.6	62.1	8.8	8.8	6	433.0
PWO-2730	27 X 30mm	284	58.6	62.1	8.8	8.8	6	432.8
PWO-3031	30 X 31mm	294	62.1	68.1	9.4	9.4	6	502.0
PWO-3032	30 X 32mm	295	62.1	68.2	9.4	9.4	6	580.0
PWO-3235	32 X 35mm	325	68.1	75.6	11.3	11.3	1	841.0
PWO-3236	32 X 36mm	325	68.1	75.6	10.6	10.6	1	841.0
PWO-3436	34 X 36mm	325	68.1	75.6	11.2	11.2	1	841.0
PWO-3538	35 X 38mm	377	76.1	85.1	12.6	12.6	1	1,050.0
PWO-3641	36 X 41mm	377	76.1	85.1	12.6	12.6	1	1,050.0
PWO-4146	41 X 46mm	426	85.1	94.6	13.9	13.9	1	1,340.0
PWO-4650	46 X 50mm	477	94.6	103.6	14.8	14.8	1	1,500.0
PWO-5055	50 X 55mm	504	108.0	115.0	16.5	16.5	1	1,800.0
PWO-5560	55 X 60mm	504	108.0	115.0	16.5	16.5	1	1,800.0
PWOI-00014932	1/4" X 9/32"	127	14.2	17.4	3.4	3.4	12	23.4
PWOI-00014516	1/4" X 5/16"	127	14.2	17.4	3.4	3.4	12	23.4
PWOI-05161132	5/16" X 11/32"	145	18.1	21.3	3.7	3.7	12	36.2
PWOI-00051638	5/16" X 3/8"	145	18.1	21.3	4.2	4.2	12	40.0
PWOI-00038716	3/8" X 7/16"	161	22.1	25.6	4.7	4.7	6	55.0
PWOI-00071612	7/16" X 1/2"	174	27.6	30.1	5.2	5.2	6	85.6
PWOI-00012916	1/2" X 9/16"	176	27.6	30.1	5.2	5.2	6	87.5
PWOI-00091658	9/16" X 5/8"	190	31.6	33.6	5.7	5.7	6	113.2
PWOI-00193258	19/32" X 5/8"	190	31.6	33.6	5.7	5.7	6	117.1
PWOI-09161116	9/16" X 11/16"	194	31.6	38.1	6.1	6.1	12	125.8
PWOI-01932116	19/32" X 11/16"	194	31.6	38.1	6.1	6.1	12	126.7
PWOI-00581116	5/8" X 11/16"	211	36.1	38.1	6.2	6.2	12	134.4
PWOI-00005834	5/8" X 3/4"	223	40.1	42.1	6.7	6.7	12	177.8



WARNING!

Wear safety goggles at all time. [User and bystanders]. Do not use chrome or handtools with power wrenches. Use only impact sockets and accessories with power impact wrenches.

WRENCHES

► Double Open End Wrench

Stock Code	Size	L (MM)	B (MM)	D (MM)	S1 (MM)	S2 (MM)	Qty (Per Box) pcs	Weight (Per Pce) g
PWOI-00111634	11/16" X 3/4"	223	40.1	42.2	6.7	6.7	12	179.9
PWOI-00003478	3/4" X 7/8"	236	44.1	48.1	7.5	7.5	12	210.6
PWOI-00131678	13/16" X 7/8"	236	44.1	48.1	7.5	7.5	12	215.0
PWOI-00781516	7/8" X 15/16"	246	46.1	50.1	7.8	7.8	12	289.0
PWOI-00015161	15/16" X 1"	267	53.1	57.6	8.4	8.4	6	371.3
PWOI-00001118	1" X 1-1/8"	267	53.1	57.6	8.4	8.4	6	363.0
PWOI-01116114	1-1/16" X 1-1/4"	294	64.1	68.1	9.4	9.4	6	507.4
PWOI-01181516	1-1/8" X 1-5/16"	294	64.1	68.1	9.4	9.4	6	502.0
PWOI-13161516	1-3/16" X 1-5/16"	294	64.1	68.1	9.4	9.4	6	502.0
PWOI-01516112	1-5/16" X 1-1/2"	325	68.1	75.6	11.2	11.2	1	841.0
PWOI-00138112	1-3/8" X 1-1/2"	377	76.1	85.1	12.6	12.6	1	1,050.0
PWOI-01716158	1-7/16" X 1-5/8"	377	76.1	85.1	12.7	12.7	1	1,280.0
PWOI-11116178	1-11/16" X 1-7/8"	426	85.1	94.6	13.9	13.9	1	1,340.0
PWOI-00113162	1-13/16" X 2"	477	94.6	103.6	14.8	14.8	1	1,500.0
PWOI-00218214	2-1/8" X 2-1/4"	504	108.0	115.0	16.5	16.5	1	1,800.0
PWOI-00214212	2-1/4" X 2-1/2"	504	108.0	115.0	16.5	16.5	1	1,850.0



WARNING!

Wear safety goggles at all time. [User and bystanders]. Do not use chrome or handtools with power wrenches. Use only impact sockets and accessories with power impact wrenches.

WRENCHES



► Offset Box Wrench

Stock Code	Size	L (MM)	B (MM)	D (MM)	S1 (MM)	S2 (MM)	Qty (Per Box) pcs	Weight (Per Pce) g
PWD-0607	6 X 7mm	165	10.3	12.0	5.2	5.7	12	40.0
PWD-0608	6 X 8mm	165	10.3	12.8	5.2	5.7	12	40.5
PWD-0708	7 X 8mm	165	10.3	12.8	5.2	5.7	12	41.0
PWD-0809	8 X 9mm	170	13.5	16.0	5.7	6.5	12	50.0
PWD-0810	8 X 10mm	170	13.5	16.2	5.7	6.5	12	62.0
PWD-1011	10 X 11mm	180	15.0	17.5	6.5	7.0	12	70.0
PWD-1012	10 X 12mm	195	16.5	18.9	6.7	7.2	12	81.0
PWD-1112	11 X 12mm	206	18.0	21.0	7.7	8.2	12	100.5
PWD-1213	12 X 13mm	206	20.0	21.0	7.7	8.5	12	105.0
PWD-1214	12 X 14mm	206	20.0	21.7	7.7	8.5	12	110.0
PWD-1317	13 X 17mm	237	21.0	25.7	9.7	9.9	12	152.2
PWD-1415	14 X 15mm	232	22.0	24.0	8.5	9.9	12	145.0
PWD-1417	14 X 17mm	237	22.5	25.7	9.7	9.9	12	161.2
PWD-1617	16 X 17mm	237	24.0	26.0	9.7	10.0	12	156.0
PWD-1719	17 X 19mm	270	26.5	29.2	10.7	11.2	12	245.2
PWD-1819	18 X 19mm	270	28.0	29.5	11.0	11.5	12	250.0
PWD-1921	19 X 21mm	292	28.7	32.2	11.4	11.9	12	271.4
PWD-1922	19 X 22mm	292	28.7	32.2	11.4	11.9	12	279.5
PWD-2022	20 X 22mm	292	28.7	32.5	11.7	12.2	12	300.0
PWD-2123	21 X 23mm	327	32.2	34.2	11.9	12.7	6	341.6
PWD-2224	22 X 24mm	327	32.2	34.2	11.9	12.7	6	342.4
PWD-2326	23 X 26mm	363	34.7	38.2	13.5	13.7	6	459.0
PWD-2426	24 X 26mm	363	34.7	38.2	13.5	13.7	6	465.0
PWD-2427	24 X 27mm	363	34.7	38.2	13.7	13.7	6	480.0
PWD-2430	24 X 30mm	363	34.7	38.2	13.7	13.7	6	527.6
PWD-2528	25 x 28mm	372	39.5	42.1	13.7	14.7	6	538.8
PWD-2629	26 x 29mm	372	39.5	42.1	13.7	14.7	6	545.6
PWD-2729	27 X 29mm	380	40.7	45.5	14.7	15.7	6	708.0
PWD-2730	27 X 30mm	380	40.7	45.5	14.7	15.7	6	710.3
PWD-2732	27 X 32mm	380	40.7	45.7	14.7	15.7	6	712.5



WARNING!

Wear safety goggles at all time. [User and bystanders]. Do not use chrome or handtools with power wrenches. Use only impact sockets and accessories with power impact wrenches.

WRENCHES

► Offset Box Wrench

Stock Code	Size	L (MM)	B (MM)	D (MM)	S1 (MM)	S2 (MM)	Qty (Per Box) pcs	Weight (Per Pce) g
PWD-2932	29 X 32mm	392	44.7	48.5	16.2	17.7	6	720.0
PWD-3032	30 X 32mm	392	45.0	48.5	16.5	18.0	6	810.0
PWD-3034	30 X 34mm	402	45.5	51.5	16.5	19.2	6	889.0
PWD-3236	32 X 36mm	402	48.5	54.5	17.2	19.2	6	895.0
PWD-3641	36 X 41mm	440	54.5	62.5	18.2	20.2	6	1,192.2
PWD-4146	41 X 46mm	470	61.7	69.7	19.2	20.7	3	1,789.0
PWD-4650	46 X 50mm	510	70.5	76.5	20.7	21.7	3	1,952.0
PWD-5560	55 X 60mm	610	83.7	91.7	22.7	23.7	3	2,731.0
PWDI-00014516	1/4" X 5/16"	165	10.3	12.8	5.2	5.7	12	33.0
PWDI-00051638	5/16" X 3/8"	170	13.5	16.2	5.7	6.2	12	47.0
PWDI-00038716	3/8" X 7/16"	180	15.2	17.2	6.2	6.7	12	58.0
PWDI-00071612	7/16" X 1/2"	206	18.0	21.0	7.7	8.2	12	101.0
PWDI-00012916	1/2" X 9/16"	206	19.5	21.7	7.7	8.2	12	105.6
PWDI-00091658	9/16" X 5/8"	232	21.7	23.5	8.2	8.7	12	131.0
PWDI-19321116	19/32" X 11/16"	237	22.5	25.7	9.7	9.9	12	160.0
PWDI-00581116	5/8" X 11/16"	237	23.7	25.7	9.7	9.9	12	162.0
PWDI-00111634	11/16" X 3/4"	270	26.5	29.2	10.7	11.2	12	245.0
PWDI-00342532	3/4" X 25/32"	270	27.7	29.2	10.7	11.2	6	249.0
PWDI-00341316	3/4" X 13/16"	292	28.7	32.2	11.4	11.9	6	271.0
PWDI-00003478	3/4" X 7/8"	292	28.7	32.2	11.4	11.9	6	280.0
PWDI-00131678	13/16" X 7/8"	292	28.7	32.2	11.4	11.9	6	304.0
PWDI-00781516	7/8" X 15/16"	327	32.2	34.2	11.9	12.7	6	342.0
PWDI-00015161	15/16" X 1"	363	34.7	38.2	13.2	13.7	6	451.0
PWDI-00001118	1" X 1-1/8"	372	39.5	42.1	13.2	14.7	6	539.0
PWDI-00116118	1-1/16" X 1-1/8"	372	39.5	42.1	13.2	14.7	6	542.0



www.promaxusatools.com



WARNING!

Wear safety goggles at all time. [User and bystanders]. Do not use chrome or handtools with power wrenches. Use only impact sockets and accessories with power impact wrenches.

WRENCHES

► Offset Box Wrench

Stock Code	Size	L (MM)	B (MM)	D (MM)	S1 (MM)	S2 (MM)	Qty (Per Box) pcs	Weight (Per Pce) g
PWDI-01116114	1-1/16" X 1-1/4"	392	44.7	48.5	16.2	17.7	6	700.0
PWDI-00118114	1-1/8" X 1-1/4"	392	45.3	48.5	16.8	17.7	6	708.1
PWDI-01181516	1-1/8" X 1-5/16"	392	45.3	48.7	16.8	18.2	6	710.0
PWDI-00114138	1-1/4" X 1-3/8"	402	48.5	54.5	17.2	19.2	6	889.0
PWDI-01141716	1-1/4" X 1-7/16"	402	48.5	54.5	17.2	19.2	6	892.0
PWDI-01516112	1-5/16" X 1-1/2"	440	54.5	62.5	18.2	20.2	6	1,192.0
PWDI-01716158	1-7/16" X 1-5/8"	440	54.7	62.7	18.2	20.2	6	1,195.0
PWDI-15811316	1-5/8" X 1-13/16"	470	61.7	69.7	19.2	20.7	6	1,789.0
PWDI-11116178	1-11/16" X 1-7/8"	470	61.7	69.7	19.2	20.7	3	1,790.0
PWDI-00113162	1-13/16" X 2"	510	70.5	76.5	20.7	21.7	3	1,952.0
PWDI-02316238	2-3/16" X 2-3/8"	610	83.7	91.7	22.7	23.7	3	2,731.0
PWDI-02142716	2-1/4" X 2-7/16"	610	83.7	91.7	22.7	23.7	3	2,735.0



WARNING!

Wear safety goggles at all time. (User and bystanders). Do not use chrome or handtools with power wrenches. Use only impact sockets and accessories with power impact wrenches.

WRENCHES



► Double Open End Wrench Set

PWO8-MM

Open End Wrench set - 8pcs

Size : 6X7mm, 8X9mm, 10X11mm,
12X13mm, 14X15mm,
16X17mm, 18X19mm,
20X22mm

Qty (per box) : 12 pcs

Weight (per pce) : 1030.0 g



► Offset Wrench Set

PWD8-MM

Offset Box Wrench set - 8pcs MM

Size : Size : 6X7mm, 8X9mm,
10X11mm, 12X13mm,
14X15mm, 16X17mm,
18X19mm, 20X22mm

Qty (per box) : 12 pcs

Weight (per pce) : 1280.0 g



► Combination Wrench Set

PW8-MM

Combination Wrench Set - 8pcs MM

Size : 8, 10, 11, 12, 13, 14,
17,19mm

Qty (per box) : 12 pcs

Weight (per pce) : 920.0 g



► Combination Wrench Set

PW14-MM

Combination Wrench Set - 14pcs MM

Size : 8, 9, 10, 11, 12, 13, 14, 15,
16, 17, 19, 21, 22, 24mm

Qty (per box) : 12 pcs

Weight (per pce) : 2110.0 g



www.promaxusa.com



WARNING!

Wear safety goggles at all time. [User and bystanders]. Do not use chrome or handtools with power wrenches
Use only impact sockets and accessories with power impact wrenches

WRENCHES



► Combination Wrench Set

PW16-MM

Combination Wrench Set - 16pcs MM

Size : 6, 7, 8, 9, 10, 11, 12, 13, 14,
17, 19, 22, 24, 27, 30, 32mm

Qty (per box) : 6 pcs

Weight (per pce) : 3900.0 g



► Combination Wrench Set

PW18-AF

Combination Wrench Set - 8pcs AF

Size : 5/16", 3/8", 7/16", 1/2",
9/16", 5/8", 11/16", 3/4"

Qty (per box) : 12 pcs

Weight (per pce) : 960.0 g



► Combination Wrench Set

PW114-AF

Combination Wrench Set - 14pcs AF

Size : 1/4", 5/16", 3/8", 7/16",
1/2", 9/16", 5/8", 11/16",
3/4", 13/16", 7/8", 15/16",
1", 1-1/16"

Qty (per box) : 12 pcs

Weight (per pce) : 2840.0 g



► Combination Wrench Set

PW116-AF

Combination Wrench Set - 16pcs AF

Size : Size : 1/4", 5/16", 3/8",
7/16", 1/2", 9/16", 5/8",
11/16", 3/4", 13/16", 7/8",
15/16", 1", 1-1/16", 1-1/8",
1-1/4"

Qty (per box) : 6 pcs

Weight (per pce) : 4380.0 g



WARNING!

Wear safety goggles at all time. (User and bystanders). Do not use chrome or handtools with power wrenches. Use only impact sockets and accessories with power impact wrenches.

WRENCHES

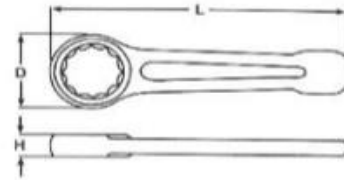

► Slogging Ring Wrench

Stock Code	Size	L (MM)	D (MM)	H (MM)	Qty (Per Box) pcs	Weight (Per Pce) g
PSR-22	22mm	165	43	14	12	230.0
PSR-24	24mm	165	43	15	12	240.0
PSR-27	27mm	175	46	16	6	290.0
PSR-30	30mm	186	52	17	6	410.0
PSR-32	32mm	186	52	17	6	400.0
PSR-34	34mm	207	59	19.5	6	540.0
PSR-36	36mm	205	58	18	6	500.0
PSR-38	38mm	225	63	19	6	650.0
PSR-41	41mm	225	66	20	6	670.0
PSR-46	46mm	235	74	22	4	870.0
PSR-50	50mm	250	80	24	4	1,080.0
PSR-55	55mm	265	86	25	4	1,150.0
PSR-60	60mm	275	93	26	2	1,500.0
PSR-65	65mm	300	102	30	2	2,570.0
PSR-70	70mm	330	115	33	2	3,540.0
PSR-75	75mm	330	117	33	1	3,480.0
PSR-80	80mm	360	130	36	1	5,260.0
PSR-85	85mm	360	130	36	1	4,670.0
PSR-90	90mm	390	142	40	1	6,790.0
PSR-95	95mm	390	146	40	1	6,770.0
PSR-100	100mm	425	155	45	1	8,910.0
PSR-105	105mm	430	160	45	1	9,080.0
PSR-110	110mm	455	167	48	1	10,160.0
PSR-115	115mm	460	178	52	1	10,930.0
PSR-120	120mm	490	184	54	1	12,310.0
PSR-125	125mm	490	186	54	1	12,830.0
PSR-130	130mm	530	202	58	1	15,300.0
PSR-135	135mm	530	202	58	1	14,500.0
PSR-140	140mm	550	210	58	1	15,300.0
PSR-145	145mm	580	228	64	1	16,200.0



www.promaxusa.com



WARNING!

Wear safety goggles at all time. [User and bystanders]. Do not use chrome or handtools with power wrenches. Use only impact sockets and accessories with power impact wrenches.

WRENCHES

▶ Slogging Ring Wrench

Stock Code	Size	L (MM)	D (MM)	H (MM)	Qty (Per Box) pcs	Weight (Per Pce) g
PSR-150	150mm	580	228	64	1	17,300.0
PSR-155	155mm	580	228	64	1	18,000.0
PSR-160	160mm	580	240	64	1	18,900.0
PSR-165	165mm	650	265	70	1	23,500.0
PSR-170	170mm	650	265	70	1	26,100.0
PSR-175	175mm	650	265	70	1	28,500.0
PSRI-01116	1-1/16"	180	46	16	12	280.0
PSRI-01118	1-1/8"	185	46	16	6	460.0
PSRI-01316	1-3/16"	185	52	17	6	466.0
PSRI-00114	1-1/4"	190	52	17	6	470.0
PSRI-01516	1-5/16"	190	52	17	6	480.0
PSRI-00138	1-3/8"	205	58	18	6	490.0
PSRI-01716	1-7/16"	205	58	18	6	510.0
PSRI-00112	1-1/2"	225	64	20	6	600.0
PSRI-01916	1-9/16"	225	64	20	4	620.0
PSRI-00158	1-5/8"	225	64	20	4	630.0
PSRI-11116	1-11/16"	225	64	20	4	640.0
PSRI-00134	1-3/4"	235	74	22	4	760.0
PSRI-11316	1-13/16"	235	74	22	4	800.0
PSRI-00178	1-7/8"	235	74	22	4	820.0
PSRI-11516	1-15/16"	251	80	24	4	900.0
PSRI-00002	2"	250	80	24	4	1,020.0
PSRI-02116	2-1/16"	265	86	25	4	1,210.0
PSRI-00218	2-1/8"	265	86	25	4	1,320.0
PSRI-02316	2-3/16"	270	86	25	4	1,330.0
PSRI-00214	2-1/4"	275	93	26	2	1,820.0
PSRI-02516	2-5/16"	280	93	26	2	1,910.0
PSRI-00238	2-3/8"	280	96	28	2	2,010.0
PSRI-02716	2-7/16"	280	96	28	2	2,230.0
PSRI-00212	2-1/2"	280	96	28	2	2,520.0
PSRI-02916	2-9/16"	300	102	30	2	2,620.0
PSRI-00258	2-5/8"	300	102	30	2	2,780.0
PSRI-21116	2-11/16"	300	102	30	2	3,180.0
PSRI-00234	2-3/4"	330	116	35	2	3,200.0
PSRI-21316	2-13/16"	330	116	35	2	3,290.0
PSRI-00278	2-7/8"	330	116	35	2	3,320.0
PSRI-21516	2-15/16"	330	116	35	2	3,360.0

**WARNING!**

Wear safety goggles at all time. [User and bystanders]. Do not use chrome or handtools with power wrenches. Use only impact sockets and accessories with power impact wrenches.

WRENCHES

► Slogging Ring Wrench

Stock Code	Size	L (MM)	D (MM)	H (MM)	Qty (Per Box) pcs	Weight (Per Pce) g
PSRI-00003	3"	330	116	35	1	3,480.0
PSRI-03116	3-1/16"	335	120	35	1	3,560.0
PSRI-00318	3-1/8"	360	130	37	1	3,890.0
PSRI-03316	3-3/16"	360	130	37	1	4,860.0
PSRI-00314	3-1/4"	360	130	37	1	4,890.0
PSRI-03516	3-5/16"	360	135	38	1	5,080.0
PSRI-00338	3-3/8"	360	135	38	1	5,180.0
PSRI-03716	3-7/16"	360	135	38	1	5,320.0
PSRI-00312	3-1/2"	360	135	38	1	5,780.0
PSRI-03916	3-9/16"	360	135	38	1	6,010.0
PSRI-00358	3-5/8"	396	142	40	1	6,300.0
PSRI-31116	3-11/16"	396	142	41	1	6,420.0
PSRI-00334	3-3/4"	396	142	42	1	6,590.0
PSRI-31316	3-13/16"	405	155	45	1	6,660.0
PSRI-00378	3-7/8"	420	155	45	1	7,610.0
PSRI-31516	3-15/16"	420	155	45	1	8,200.0
PSRI-00004	4"	420	155	46	1	9,210.0
PSRI-00418	4-1/8"	420	163	46	1	9,520.0
PSRI-00414	4-1/4"	450	167	48	1	9,780.0
PSRI-00412	4-1/2"	450	175	48	1	10,890.0
PSRI-00458	4-5/8"	450	175	48	1	11,320.0
PSRI-00434	4-3/4"	480	187	54	1	12,630.0
PSRI-00478	4-7/8"	480	187	56	1	12,900.0
PSRI-00005	5"	480	195	58	1	13,860.0
PSRI-00518	5-1/8"	520	202	58	1	14,120.0
PSRI-00514	5-1/4"	520	202	58	1	14,230.0
PSRI-00538	5-3/8"	520	206	58	1	14,700.0
PSRI-00512	5-1/2"	520	212	58	1	14,990.0
PSRI-00558	5-5/8"	580	212	58	1	15,410.0
PSRI-00534	5-3/4"	580	220	60	1	16,520.0
PSRI-00578	5-7/8"	580	228	60	1	17,280.0
PSRI-00006	6"	580	240	64	1	19,750.0



WARNING!

Wear safety goggles at all time. [User and bystanders]. Do not use chrome or handtools with power wrenches. Use only impact sockets and accessories with power impact wrenches.

WRENCHES

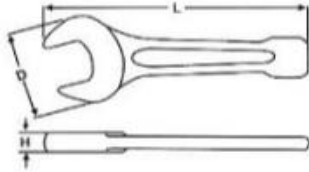

► Open End Slogging Wrench

Stock Code	Size	L (MM)	D (MM)	H (MM)	Qty (Per Box) pcs	Weight (Per Pce) g
PSO-24	24mm	190	56	12.5	12	350.0
PSO-27	27mm	190	56	13.5	12	400.0
PSO-30	30mm	206	66	14	6	550.0
PSO-32	32mm	206	66	14	6	470.0
PSO-36	36mm	217	73	17	6	850.0
PSO-38	38mm	246	85	17	6	950.0
PSO-41	41mm	246	85	17	6	870.0
PSO-46	46mm	252	95	20	4	1,290.0
PSO-50	50mm	256	104	20	4	1,220.0
PSO-55	55mm	268	112	20	4	1,600.0
PSO-60	60mm	302	128	24	2	2,240.0
PSO-65	65mm	302	128	27	1	2,160.0
PSO-70	70mm	340	150	30	1	3,950.0
PSO-75	75mm	340	150	30	1	4,010.0
PSO-80	80mm	365	167	34	1	6,040.0
PSO-85	85mm	365	170	34	1	6,070.0
PSO-90	90mm	415	195	34	1	7,090.0
PSO-95	95mm	415	195	34	1	6,860.0
PSO-100	100mm	485	215	44	1	11,500.0
PSO-105	105mm	485	215	44	1	11,200.0
PSO-110	110mm	510	235	47	1	13,200.0
PSO-115	115mm	510	235	47	1	16,200.0
PSO-120	120mm	545	255	50	1	17,500.0
PSO-125	125mm	545	255	50	1	18,600.0
PSO-130	130mm	575	275	55	1	19,400.0
PSO-135	135mm	575	275	55	1	21,300.0
PSO-140	140mm	575	275	55	1	22,700.0
PSO-145	145mm	640	305	60	1	25,000.0
PSO-150	150mm	640	305	60	1	29,900.0
PSO-155	155mm	640	305	60	1	34,300.0



WARNING!

Wear safety goggles at all time. [User and bystanders]. Do not use chrome or handtools with power wrenches. Use only impact sockets and accessories with power impact wrenches.

WRENCHES

► Open End Slogging Wrench

Stock Code	Size	L (MM)	D (MM)	H (MM)	Qty (Per Box) pcs	Weight (Per Pce) g
PSO-160	160mm	640	305	60	1	38,400.0
PSO-165	165mm	715	342	70	1	40,000.0
PSO-170	170mm	715	342	70	1	42,000.0
PSO-175	175mm	715	342	70	1	44,000.0
PSOI-01116	1-1/16"	180	56	16	12	350.0
PSOI-00118	1-1/8"	180	56	16	12	400.0
PSOI-01316	1-3/16"	190	62	17	6	460.0
PSOI-00114	1-1/4"	190	62	17	6	500.0
PSOI-01516	1-5/16"	190	62	17	6	570.0
PSOI-00138	1-3/8"	215	76	17.5	6	650.0
PSOI-01716	1-7/16"	215	76	17.5	6	710.0
PSOI-01112	1-1/2"	215	76	17.5	6	800.0
PSOI-01158	1-5/8"	235	86	18.5	6	950.0
PSOI-11116	1-11/16"	235	86	18.5	4	1,120.0
PSOI-00134	1-3/4"	255	86	18.5	4	1,250.0
PSOI-11316	1-13/16"	255	98	20	4	1,325.0
PSOI-00178	1-7/8"	255	98	20	4	1,400.0
PSOI-11516	1-15/16"	275	105	21	4	1,540.0
PSOI-00002	2"	275	105	21	4	1,600.0
PSOI-02116	2-1/16"	275	105	21	4	1,850.0
PSOI-00218	2-1/8"	300	105	21	4	2,050.0
PSOI-02316	2-3/16"	300	116	23	4	2,110.0
PSOI-00214	2-1/4"	300	116	23	1	2,200.0
PSOI-02516	2-5/16"	310	116	24.5	1	2,360.0
PSOI-00238	2-3/8"	320	128	24.5	1	2,450.0
PSOI-00212	2-1/2"	330	128	25	1	2,870.0
PSOI-02916	2-9/16"	342	138	27	1	3,250.0
PSOI-00258	2-5/8"	342	138	27	1	3,745.0
PSOI-21116	2-11/16"	375	154	30	1	4,000.0
PSOI-00234	2-3/4"	375	154	30	1	4,250.0
PSOI-21316	2-13/16"	375	154	30	1	4,420.0
PSOI-00278	2-7/8"	375	154	30	1	4,500.0
PSOI-21516	2-15/16"	375	154	30	1	4,875.0
PSOI-00003	3"	375	154	30	1	5,150.0
PSOI-00318	3-1/8"	408	174	34	1	6,250.0
PSOI-00314	3-1/4"	408	174	34	1	6,150.0



WARNING!

Wear safety goggles at all time. [User and bystanders]. Do not use chrome or handtools with power wrenches. Use only impact sockets and accessories with power impact wrenches.

WRENCHES

► Open End Slogging Wrench

Stock Code	Size	L (MM)	D (MM)	H (MM)	Qty (Per Box) pcs	Weight (Per Pce) g
PSOI-00338	3-3/8"	408	174	34	1	6,050.0
PSOI-00312	3-1/2"	445	194	38	1	7,850.0
PSOI-00358	3-5/8"	445	194	38	1	7,950.0
PSOI-00334	3-3/4"	445	194	38	1	8,700.0
PSOI-00378	3-7/8"	485	215	44	1	9,250.0
PSOI-00004	4"	485	215	44	1	9,950.0
PSOI-00418	4-1/8"	485	215	44	1	10,800.0
PSOI-00414	4-1/4"	510	235	47	1	13,200.0
PSOI-00438	4-3/8"	510	235	47	1	13,000.0
PSOI-00412	4-1/2"	510	235	47	1	13,200.0
PSOI-00458	4-5/8"	510	235	47	1	13,650.0
PSOI-00434	4-3/4"	545	255	50	1	17,700.0
PSOI-00478	4-7/8"	545	255	50	1	17,400.0
PSOI-00005	5"	545	255	50	1	17,450.0
PSOI-00518	5-1/8"	575	275	55	1	18,100.0
PSOI-00514	5-1/4"	575	275	55	1	18,750.0
PSOI-00538	5-3/8"	575	275	55	1	18,650.0
PSOI-00512	5-1/2"	575	275	55	1	19,300.0
PSOI-00558	5-5/8"	640	305	60	1	27,400.0
PSOI-00534	5-3/4"	640	305	60	1	27,450.0
PSOI-00578	5-7/8"	640	305	60	1	27,900.0
PSOI-00006	6"	640	305	60	1	28,000.0



WARNING!

Wear safety goggles at all time. [User and bystanders]. Do not use chrome or handtools with power wrenches. Use only impact sockets and accessories with power impact wrenches.

WRENCHES

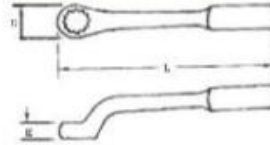

► Offset Handle Slogging Ring Wrench

Stock Code	Size	L (MM)	D (MM)	H (MM)	Qty (Per Box) pcs	Weight (Per Pce) g
PCRS-22	22mm	247.20	31.20	19.05	6	889.0
PCRS-24	24mm	252.80	34.70	19.05	6	960.0
PCRS-27	27mm	260.35	38.10	22.23	6	1,070.0
PCRS-30	30mm	279.40	44.45	22.23	3	1,290.0
PCRS-32	32mm	280.50	46.70	22.23	3	1,425.0
PCRS-36	36mm	293.70	50.80	30.16	3	1,570.0
PCRS-38	38mm	295.00	53.00	30.16	3	2,000.0
PCRS-41	41mm	311.15	57.15	30.16	3	2,050.0
PCRS-46	46mm	313.00	66.85	30.16	2	2,310.0
PCRS-50	50mm	333.00	76.00	34.92	2	2,540.0
PCRS-55	55mm	352.40	82.55	34.92	2	3,320.0
PCRS-60	60mm	355.10	87.30	34.92	2	3,940.0
PCRS-65	65mm	390.50	95.00	44.45	1	3,740.0
PCRS-70	70mm	392.00	100.64	44.45	1	4,260.0
PCRS-75	75mm	419.10	107.15	44.45	1	5,500.0
PCRSI-01116	1-1/16"	260.35	38.10	22.35	6	1,070.0
PCRSI-00118	1-1/8"	279.40	38.10	22.35	6	1,360.0
PCRSI-01316	1-3/16"	279.40	44.45	22.35	3	1,290.0
PCRSI-00114	1-1/4"	279.40	46.10	22.35	3	1,290.0
PCRSI-01516	1-5/16"	279.40	48.70	22.35	3	1,410.0
PCRSI-00138	1-3/8"	293.62	50.80	30.20	3	1,610.0
PCRSI-01716	1-7/16"	293.62	55.00	30.20	3	1,560.0
PCRSI-00112	1-1/2"	295.00	60.45	30.20	2	1,570.0
PCRSI-00158	1-5/8"	320.80	65.00	30.20	2	2,000.0
PCRSI-11116	1-11/16"	322.00	69.85	30.20	2	2,030.0
PCRSI-00134	1-3/4"	323.85	70.40	30.20	2	2,370.0
PCRSI-11316	1-13/16"	330.20	72.15	30.20	2	2,410.0
PCRSI-00178	1-7/8"	335.03	74.60	30.20	2	2,500.0
PCRSI-11516	1-15/16"	338.00	76.20	35.05	2	2,580.0



www.promaxusa.com



WARNING!

Wear safety goggles at all time. (User and bystanders). Do not use chrome or handtools with power wrenches. Use only impact sockets and accessories with power impact wrenches.

WRENCHES

▶ Offset Handle Slogging Ring Wrench

Stock Code	Size	L (MM)	D (MM)	H (MM)	Qty (Per Box) pcs	Weight (Per Pce) g
PCRSI-00002	2"	338.00	79.00	35.05	2	3,000.0
PCRSI-00218	2-1/8"	355.60	82.55	35.05	2	3,450.0
PCRSI-02316	2-3/16"	357.00	86.70	35.05	1	3,500.0
PCRSI-00214	2-1/4"	358.20	90.00	35.05	1	3,750.0
PCRSI-02516	2-5/16"	360.00	92.08	35.05	1	3,800.0
PCRSI-00238	2-3/8"	362.80	93.40	35.05	1	3,940.0
PCRSI-00212	2-1/2"	365.25	94.00	44.45	1	3,810.0
PCRSI-02916	2-9/16"	390.50	95.25	44.45	1	4,100.0
PCRSI-00258	2-5/8"	403.70	100.75	44.45	1	4,540.0
PCRSI-00234	2-3/4"	410.15	104.00	44.45	1	5,000.0
PCRSI-00278	2-7/8"	419.10	107.95	44.45	1	5,810.0
PCRSI-21516	2-15/16"	422.40	111.20	44.45	1	5,900.0
PCRSI-00003	3"	438.00	120.00	44.45	1	6,200.0

▶ Construction Open Wrench

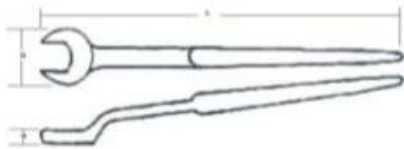

Stock Code	Size	L (MM)	D (MM)	H (MM)	Qty (Per Box) pcs	Weight (Per Pce) g
PCOSI-00034	3/4"	312.70	50.80	11.11	1	630
PCOSI-00078	7/8"	368.30	55.56	13.50	1	640
PCOSI-01516	15/16"	368.30	63.50	13.50	1	650
PCOSI-00001	1"	368.30	55.56	13.50	1	680
PCOSI-01116	1-1/16"	438.20	66.68	15.88	1	1080
PCOSI-00118	1-1/8"	438.20	60.30	15.88	1	1100
PCOSI-00114	1-1/4"	438.20	63.50	17.46	1	1250
PCOSI-01516	1-5/16"	482.60	73.03	17.46	1	1400
PCOSI-01716	1-7/16"	541.30	80.96	19.05	1	1900
PCOSI-00112	1-1/2"	541.30	82.55	19.05	1	1920
PCOSI-00158	1-5/8"	541.30	80.96	22.23	1	1950
PCOSI-11316	1-13/16"	587.40	95.25	25.40	1	2900
PCOSI-00178	1-7/8"	587.40	92.08	25.40	1	2950
PCOSI-00002	2"	587.40	95.25	25.40	1	3000



WARNING!

Wear safety goggles at all time. [User and bystanders]. Do not use chrome or handtools with power wrenches. Use only impact sockets and accessories with power impact wrenches.



**TORQUE
WRENCH**

TORQUE WRENCH

▶ Adjustable Torque Wrench



Spare Parts



Part No.	Square Drive	Range	L (mm)	Weight (kg)	Part No.	Square Drive	Range	L (mm)	Weight (kg)
PTW-N1430	1/4"	6-30Nm	350	0.74	PTW-N14250F	1/4"	40-250in.lb	350	0.74
PTW-N3830	3/8"	6-30Nm	350	0.74	PTW-N38250F	3/8"	40-250in.lb	350	0.74
PTW-N38110	3/8"	19-110Nm	385	0.96	PTW-N3880F	3/8"	15-80ft.lb	385	0.96
PTW-N12110	1/2"	19-110Nm	385	0.96	PTW-N12080F	1/2"	15-80ft.lb	385	0.96
PTW-N12210	1/2"	40-210Nm	535	1.70	PTW-N12150F	1/2"	30-150ft.lb	535	1.70
PTW-N12350	1/2"	70-350Nm	645	2.54	PTW-N12250F	1/2"	50-250ft.lb	645	2.54
PTW-N34500	3/4"	100-500Nm	865	3.66	PTW-N34300F	3/4"	50-300ft.lb	865	3.66
PTW-N34700	3/4"	140-700Nm	1092	5.94	PTW-N34600F	3/4"	100-600ft.lb	1092	5.94
PTW-N34980	3/4"	140-980Nm	1230	6.46	PTW-N34700F	3/4"	100-700ft.lb	1230	6.46
PTW-N1980	1"	140-980Nm	1230	6.46	PTW-N1700F	1"	100-700ft.lb	1230	6.46
PTW-N11500	1"	300-1500Nm	1700	11.58	PTW-N11000F	1"	200-1000ft.lb	1700	11.58

▶ Bi-Directional Torque Wrench



Spare Parts



Part No.	Square Drive	Range	L (mm)	Weight (kg)	Part No.	Square Drive	Range	L (mm)	Weight (kg)
PDT-N3880	3/8"	15-80Nm	383	0.74	PDT-3860F	3/8"	10-60ft.lb	383	0.74
PDT-N38110	3/8"	19-110Nm	383	0.96	PDT-3880F	3/8"	15-80ft.lb	383	0.96
PDT-N12210	1/2"	40-210Nm	535	1.70	PDT-12150F	1/2"	30-150ft.lb	535	1.70
PDT-N12350	1/2"	70-350Nm	645	2.54	PDT-12250F	1/2"	50-250ft.lb	645	2.54
PDT-N34500	3/4"	100-500Nm	865	3.66	PDT-34300F	3/4"	50-300ft.lb	865	3.66
PDT-N34700	3/4"	140-700Nm	1088	5.94	PDT-34600F	3/4"	100-600ft.lb	1088	5.94
PDT-N34980	3/4"	140-980Nm	1230	6.46	PDT-34700F	3/4"	100-700ft.lb	1230	6.46
PDT-N1980	1"	140-980Nm	1230	6.46	PDT-1700F	1"	100-700ft.lb	1230	6.46



WARNING!

Wear safety goggles at all time. (User and bystanders). Do not use chrome or handtools with power wrenches. Use only impact sockets and accessories with power impact wrenches.

TORQUE WRENCH

► Bi-Directional Torque Wrench



Spare Parts



Part No.	Square Drive	Range	L (mm)	Weight (kg)
PPR-N1405	1/4"	1-5Nm	200	0.36
PPR-N1430	1/4"	6-30Nm	257	0.44
PPR-N38110	3/8"	20-110Nm	436	1.12
PPR-N12210	1/2"	40-210Nm	495	1.47
PPR-N12350	1/2"	70-350Nm	560	1.62
PPR-N34450	3/4"	75-450Nm	815	3.30
PPR-N34800	3/4"	100-800Nm	1000	7.08
PPR-N341500	3/4"	300-1500Nm	1700	11.80

Part No.	Square Drive	Range	L (mm)	Weight (kg)
PPR-1450I	1/4"	10-50in.lb	200	0.36
PPR-14200I	1/4"	40-200in.lb	257	0.44
PPR-38100F	3/8"	10-100ft.lb	436	1.12
PPR-12150F	1/2"	30-150ft.lb	495	1.47
PPR-12250F	1/2"	30-250ft.lb	560	1.62
PPR-34300F	3/4"	50-300ft.lb	815	3.30
PPR-34600F	3/4"	100-600ft.lb	1000	7.08
PPR-341000F	3/4"	200-1000ft.lb	1700	11.80

► Adjustable Torque Wrench With Flexible Head



Spare Parts



Part No.	Square Drive	Range	L (mm)	Weight (kg)
PHPR-N1405	1/4"	1-5Nm	215	0.38
PHPR-N1430	1/4"	6-30Nm	272	0.46
PHPR-N38110	3/8"	20-110Nm	460	1.20
PHPR-N12210	1/2"	40-210Nm	515	1.60
PHPR-N12350	1/2"	70-350Nm	583	1.77

Part No.	Square Drive	Range	L (mm)	Weight (kg)
PHPR-1450I	1/4"	10-50in.lb	215	0.38
PHPR-14200I	1/4"	40-200in.lb	272	0.46
PHPR-38100F	3/8"	10-100ft.lb	460	1.20
PHPR-12150F	1/2"	30-150ft.lb	515	1.60
PHPR-12250F	1/2"	30-250ft.lb	583	1.77



WARNING!

Wear safety goggles at all time. (User and bystanders). Do not use chrome or handtools with power wrenches. Use only impact sockets and accessories with power impact wrenches.

TORQUE WRENCH

► Extension Ratchet Handle

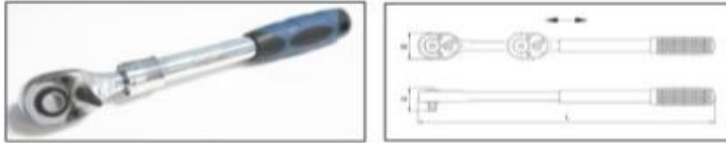

Part No.	Square Drive	Teeth	W mm	H mm	L mm	Weight kg
PEP-1224	1/2"	24	47	43	330/485	1.04
PEP-1248	1/2"	48	47	43	330/485	1.04

► Torque Multiplier

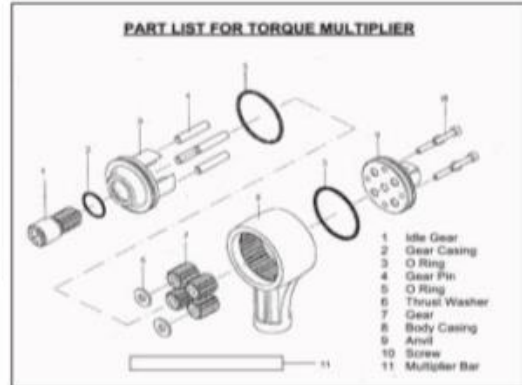
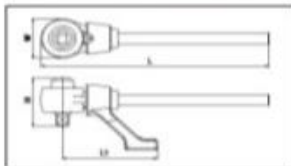

Part No.	Square Drive	L (mm)	L1 (mm)	W (mm)	H (mm)	Weight (kg)
PMT-F12M34	Input : 1/2" Max : 500Nm / 365 Ft-Lb Output : 3/4" Max : 1500Nm / 1100Ft-Lb Ratio : Output / Input = 3/1	420	157	73	84	3.09
PMT-F34M1	Input : 3/4" Max : 1000Nm / 730 Ft-Lb Output : 1" Max : 3000Nm / 2200Ft-Lb Ratio : Output / Input = 3/1	500	206	92	104	6.49



www.promaxusa.com



WARNING!

Wear safety goggles at all time. [User and bystanders]. Do not use chrome or handtools with power wrenches. Use only impact sockets and accessories with power impact wrenches.

TORQUE WRENCH

► Torque Multiplier X 9



Part No.	Square Drive	Weight (kg)
PMT-F12M34-9	Input : 1/2" F Max : 160Nm / 120 Ft-Lb Output : 3/4" M Max : 1500Nm / 1100Ft-Lb Ratio : Output / Input = 9/1	4.00

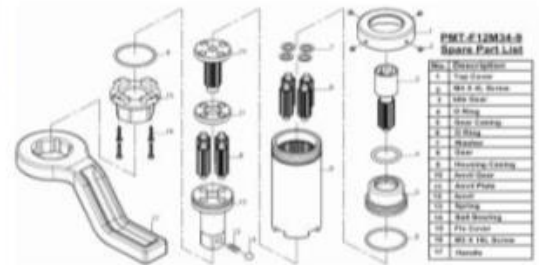

WARNING!

Wear safety goggles at all time. [User and bystanders]. Do not use chrome or handtools with power wrenches. Use only impact sockets and accessories with power impact wrenches.

TORQUE WRENCH

► Digital Adjustable Torque Wrench



Part No.	Square Drive	Range	L (mm)	Weight (kg)
PMET-38100N	3/8"	10-100Nm	440	0.95
PMET-12100NS	1/2"	10-100Nm	440	1.06
PMET-12200N	1/2"	20-200Nm	580	1.35

Specifications

- Accuracy : $\pm 1\%$
- Memory : 10 Readings
- Unit Selection : Nm, ft.lb, in.lb, kg-m
- Operating Temperature : $-15^{\circ}\text{C} \sim 55^{\circ}\text{C}$
- Storage Temperature : $-40^{\circ}\text{C} \sim 85^{\circ}\text{C}$
- Humidity : 0-90%
- Battery : 1.5V AA Batteries * 3 (Do not use low self-discharge battery)
- Warranty : 1 year in normal statement.

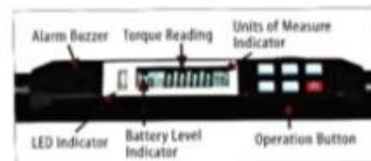

► Adjustable Torque Wrench (For Pipe)



Part No.	Square Drive	Range	L (mm)	Weight (kg)
PPIT-350N	2-1/2"	70-350Nm	825	3.70
PPIT-500N	2-1/2"	100-500Nm	920	4.30



www.promaxusa.com



WARNING!

Wear safety goggles at all time. (User and bystanders). Do not use chrome or handtools with power wrenches. Use only impact sockets and accessories with power impact wrenches.

TORQUE WRENCH

► Micrometer Torque Wrench Set (11 pcs/set)



Part No.	Square Drive	Range	Contents
PNTP-110N11	3/8"	19-110Nm	1 pce - 3/8"Dr Micrometer Torque Wrench 6 pcs - 3/8"Dr Sockets : 10,12,14,17,19,21mm 4 pcs - 3/8"Dr Hex Socket Bit : 4,5,6,8mm
PNTP-80F11	3/8"	15-80ft.lb	1 pce - 3/8"Dr Micrometer Torque Wrench 6 pcs - 3/8"Dr Sockets : 10,12,14,17,19,21mm 4 pcs - 3/8"Dr Hex Socket Bit : 4,5,6,8mm

► Interchangeable Torque Handle Set (8 pcs/set)



Part No.	Range	Contents
PATP-80N8	15-80 Nm	1 pce - Interchangeable Torque Handle - 14X18 1 pce - 1/2"Dr Ratchet Head - 14X18 6 pcs - Open End Head - 14X18 : 17,22,24,26,27,29mm
PATP-60F8	10-60ft.lb	1 pce - Interchangeable Torque Handle - 14 X 18 1 pce - 1/2"Dr Ratchet Head - 14 X 18 6 pcs - Open End Head -14X18 : 17,22,24,26,27,29mm



WARNING!

Wear safety goggles at all time. [User and bystanders]. Do not use chrome or handtools with power wrenches. Use only impact sockets and accessories with power impact wrenches.

TORQUE WRENCH

► Interchangeable Torque Handle Set (11 pcs/set)



Part No.	Range	Contents
PTW-N11NM	40-210Nm	1 pce - Interchangeable Torque Wrench - 14X18 1 pce - 1/2" Dr Ratchet - 14X18 9 pcs - Open End Heads - 14X18 : 13,14,15,17,19,22,24,27,30mm
PTW-N11FT	30-150ft.lb	1 pce - Interchangeable Torque Wrench - 14X18 1 pce - 1/2" Dr Ratchet - 14X18 9 pcs - Open End Heads - 14X18 : 13,14,15,17,19,22,24,27,30mm

► Interchangeable Torque Handle Set (8 pcs/set)



Part No.	Range	Contents
PATP-210N/8	40-210Nm	1 pce - Interchangeable Torque Handle - 14X18 7 pcs - Hook & Collet Head - 14X18 : OZ16,OZ25,OZ32,TG75,TG100, TG150, MLC12
PATP-150F/8	30-150ft.lb	1 pce - Interchangeable Torque Handle - 14X18 7 pcs - Hook & Collet Head - 14X18 : OZ16,OZ25,OZ32,TG75,TG100, TG150, MLC12



WARNING!

Wear safety goggles at all time. [User and bystanders]. Do not use chrome or handtools with power wrenches
Use only impact sockets and accessories with power impact wrenches

TORQUE WRENCH

► Torque Handle Set (11pcs/set)



Part No.	Range	Contents
PMIT15N11	3-15Nm	1 pce - Interchangeable Torque Handle 3-15Nm - 9X12 1 pce - 1/4"Dr Ratchet Handle - 9X12 9pcs - Open End Head - 9X12 : 5.1 ,5.8 ,6.1 ,6.3 ,6.4 ,6.5 ,6.7 ,6.9mm, 6TP-Spline
PMIT-150I11	30-150in.lb	1 pce - Interchangeable Torque Handle 30-150in.lb - 9X12 1 pce - 1/4"Dr Ratchet Handle - 9X12 9pcs - Open End Head - 9X12 : 5.1 ,5.8 ,6.1 ,6.3 ,6.4 ,6.5 ,6.7 ,6.9mm, 6TP-Spline

► Preset Torque Screwdriver



Part No.	Square Drive	Range	L (mm)	Weight (kg)
PFTD-3.5N	4mm	0.5-3.5Nm / 5-35in.lb	130	130



Part No.	Square Drive	Range	L (mm)	Weight (kg)
PFTD-L-5N	6.35mm	3.5-5Nm	150	158
PFTD-L-12N	6.35mm	6-12Nm	160	173



WARNING!

Wear safety goggles at all time. [User and bystanders]. Do not use chrome or handtools with power wrenches. Use only impact sockets and accessories with power impact wrenches.

TORQUE WRENCH

► Torque Screwdriver Set



Part No.	Square Drive	Capacity	Contents
PTS-B14FT	1/4"	10-50in-lb	Star Bits : T-10, T-15, T-20, T-25, T-30, T-40 Hex Bits : 3, 4, 5, 6 Slotted Bits : 4, 6 Philips Bits : OX2, 1X2, 2X2, 3X2 Bit Holder For 6.35mm use
PTS-B14NM	1/4"	1-5Nm	Star Bits : T-10, T-15, T-20, T-25, T-30, T-40 Hex Bits : 3, 4, 5, 6 Slotted Bits : 4, 6 Philips Bits : OX2, 1X2, 2X2, 3X2 Bit Holder For 6.35mm use

► Preset 3-IN-1 Torque Wrench Set



Part No.	Square Drive	Preset Ran(ge)	Weight (kg)
PSEK-108N	1/2"	85N, 103N, 108N	12.3

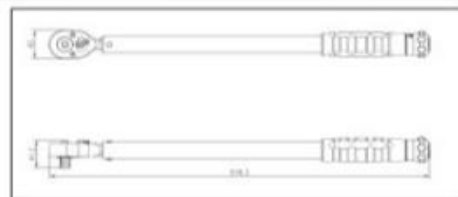

WARNING!

Wear safety goggles at all time. (User and bystanders). Do not use chrome or handtools with power wrenches. Use only impact sockets and accessories with power impact wrenches.

TORQUE WRENCH

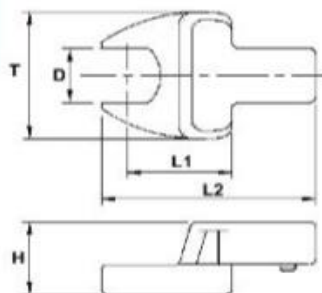

► Torque Handle Fittings (Open End Head)

Part No.	D (MM)	Head (MM)	T (MM)	H (MM)	L2 (MM)	L1 (MM)	Weight (Per Pce) g
PSH-0912-07	7	9X12	24.00	14.00	37.00	17.50	38
PSH-0912-08	8	9X12	24.00	14.00	37.00	17.50	38
PSH-0912-09	9	9X12	24.00	14.50	37.50	17.50	39
PSH-0912-10	10	9X12	30.00	14.50	38.50	17.50	42
PSH-0912-11	11	9X12	30.00	14.50	38.50	17.50	43
PSH-0912-12	12	9X12	30.00	16.00	39.50	17.50	48
PSH-0912-13	13	9X12	30.00	16.00	42.00	20.00	52
PSH-0912-14	14	9X12	35.00	17.00	42.00	20.00	59
PSH-0912-15	15	9X12	35.00	17.00	42.74	20.00	59
PSH-0912-16	16	9X12	38.00	17.50	43.20	20.00	67
PSH-0912-17	17	9X12	38.00	17.50	43.60	20.00	67
PSH-0912-18	18	9X12	42.00	18.00	46.00	22.00	75
PSH-0912-19	19	9X12	42.00	18.00	46.43	22.00	75
PSH-1418-13	13	14X18	35.00	21.00	62.50	32.00	148
PSH-1418-14	14	14X18	35.00	22.00	63.00	32.00	154
PSH-1418-15	15	14X18	35.00	22.50	64.00	32.00	154
PSH-1418-16	16	14X18	38.00	23.00	64.00	32.00	173
PSH-1418-17	17	14X18	38.00	23.00	64.00	32.00	173
PSH-1418-18	18	14X18	42.00	24.00	65.00	32.00	192
PSH-1418-19	19	14X18	42.00	24.50	65.00	32.00	193
PSH-1418-21	21	14X18	50.00	25.00	66.00	32.00	217
PSH-1418-22	22	14X18	53.00	26.00	66.00	32.00	222
PSH-1418-24	24	14X18	53.00	26.00	67.00	32.00	225
PSH-1418-26	26	14X18	60.00	27.00	70.00	33.00	273
PSH-1418-27	27	14X18	60.00	27.00	70.00	34.00	281
PSH-1418-29	29	14X18	66.00	28.00	74.00	36.00	312
PSH-1418-30	30	14X18	66.00	28.00	74.00	36.00	312
PSH-1418-32	32	14X18	66.00	28.50	76.50	37.50	322
PSH-1418-34	34	14X18	73.00	28.50	82.40	43.00	365



WARNING!

Wear safety goggles at all time. [User and bystanders]. Do not use chrome or handtools with power wrenches. Use only impact sockets and accessories with power impact wrenches.

TORQUE WRENCH

► Torque Handle Fittings (Open End Head)

Part No.	D (MM)	Head (MM)	T (MM)	H (MM)	L2 (MM)	L1 (MM)	Weight (Per Pce) g
PSH-1418-36	36	14X18	73.00	28.50	82.40	42.00	368
PSH-1418-38	38	14X18	73.00	28.50	82.40	41.00	366
PSH-1418-40	40	14X18	82.00	28.50	83.40	42.00	395
PSH-1418-41	41	14X18	82.00	29.00	83.50	42.00	400
PSH-1418-42	42	14X18	82.00	29.00	83.40	42.00	405
PSH-1418-44	44	14X18	91.00	29.00	86.40	41.20	425
PSH-1418-46	46	14X18	91.00	29.00	86.40	43.00	436

► Torque Handle Fittings (Ring End Head)

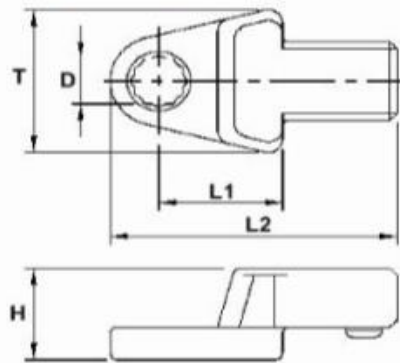

Part No.	D (MM)	Head (MM)	T (MM)	H (MM)	L2 (MM)	L1 (MM)	Weight (Per Pce) g
PSRH-0912-07	7	9 X 12	22.00	14.00	40.60	17.50	38
PSRH-0912-08	8	9 X 12	22.00	14.00	40.60	17.50	38
PSRH-0912-09	9	9 X 12	24.00	14.50	42.10	17.50	39
PSRH-0912-10	10	9 X 12	24.00	14.50	42.10	17.50	42
PSRH-0912-11	11	9 X 12	24.00	15.00	43.50	17.50	43
PSRH-0912-12	12	9 X 12	24.00	15.00	43.50	17.50	48
PSRH-0912-13	13	9 X 12	24.00	16.00	46.95	20.00	52
PSRH-0912-14	14	9 X 12	24.00	16.00	46.95	20.00	59
PSRH-0912-15	15	9 X 12	24.00	17.00	48.20	20.00	59
PSRH-0912-16	16	9 X 12	24.00	17.00	48.20	20.00	67
PSRH-0912-17	17	9 X 12	24.00	18.00	51.45	22.00	67
PSRH-0912-18	18	9 X 12	24.00	18.00	51.45	22.00	75



WARNING!

Wear safety goggles at all time. [User and bystanders]. Do not use chrome or handtools with power wrenches. Use only impact sockets and accessories with power impact wrenches.

TORQUE WRENCH

► Torque Handle Fittings (Ring End Head)

Part No.	D (MM)	Head (MM)	T (MM)	H (MM)	L2 (MM)	L1 (MM)	Weight (Per Pce) g
PSRH-0912-19	19	9 X 12	24.00	18.00	51.45	22.00	75
PSRH-1418-13	13	14 X 18	35.00	22.00	70.40	32.00	148
PSRH-1418-14	14	14 X 18	35.00	22.00	70.40	32.00	154
PSRH-1418-15	15	14 X 18	35.00	22.00	70.40	32.00	154
PSRH-1418-16	16	14 X 18	35.00	23.00	70.40	32.00	173
PSRH-1418-17	17	14 X 18	35.00	23.00	70.40	32.00	173
PSRH-1418-18	18	14 X 18	40.00	24.00	72.30	32.00	192
PSRH-1418-19	19	14 X 18	40.00	24.00	72.30	32.00	193
PSRH-1418-21	21	14 X 18	40.00	25.00	73.50	32.00	217
PSRH-1418-22	22	14 X 18	40.00	25.00	74.40	32.00	222
PSRH-1418-24	24	14 X 18	40.00	25.00	75.85	32.00	225
PSRH-1418-26	26	14 X 18	40.00	25.00	75.85	32.00	273
PSRH-1418-27	27	14 X 18	40.00	27.00	79.40	34.00	281
PSRH-1418-29	29	14 X 18	40.00	28.00	82.40	36.00	312
PSRH-1418-30	30	14 X 18	40.00	28.00	82.40	36.00	312
PSRH-1418-32	32	14 X 18	40.00	28.00	83.65	36.00	322
PSRH-1418-34	34	14 X 18	40.00	29.00	86.90	38.00	365
PSRH-1418-36	36	14 X 18	40.00	29.00	88.15	38.00	368
PSRH-1418-38	38	14 X 18	40.00	30.00	91.40	40.00	370
PSRH-1418-40	40	14 X 18	40.00	30.00	92.65	40.00	395
PSRH-1418-41	41	14 X 18	40.00	31.00	95.90	42.00	400
PSRH-1418-42	42	14 X 18	40.00	31.00	95.90	42.00	405
PSRH-1418-44	44	14 X 18	40.00	31.00	99.15	44.00	425
PSRH-1418-46	46	14 X 18	40.00	31.00	100.40	44.00	436



WARNING!

Wear safety goggles at all time. [User and bystanders]. Do not use chrome or handtools with power wrenches. Use only impact sockets and accessories with power impact wrenches.



SCREWDRIVER

SCREWDRIVER

Go-Thru Screwdriver

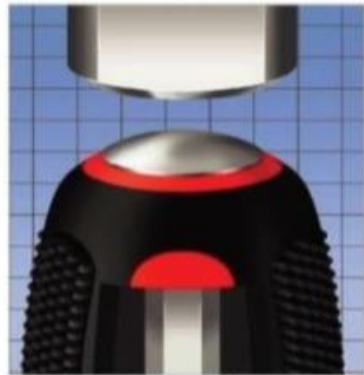
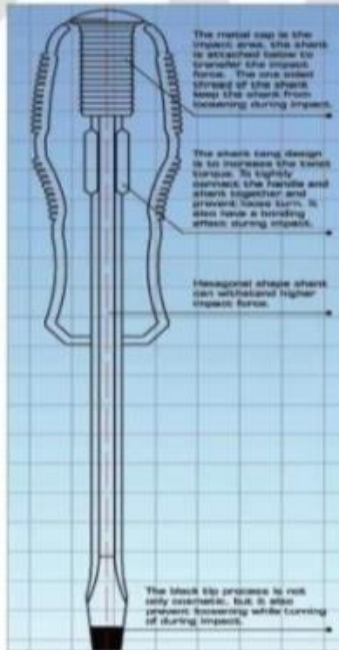

Due to the Go-Thru design with the Flex-Dot, the screwdriver can absorb the vibration produced during impact. This effectively eliminates the pain and discomfort caused the impact vibration and increase work efficiency.



www.promaxusatools.com



WARNING!

Wear safety goggles at all time. [User and bystanders]. Do not use chrome or handtools with power wrenches. Use only impact sockets and accessories with power impact wrenches.

SCREWDRIVER

► Go Thru Slotted Screwdriver

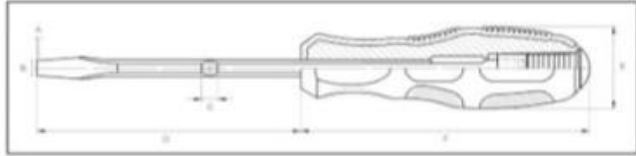

Part No.	Size	A	B	C	D	E	F
1PHS-0575	5 X 75m	0.8	5.0	5.0	75	31.0	100.0
1PHS-06100	6 X 100m	1.0	6.5	6.0	100	34.0	110.0
1PHS-06150	6 X 150m	1.0	6.5	6.0	150	34.0	110.0
1PHS-08150	8 X 150m	1.2	8.0	8.0	150	38.0	122.0
1PHS-08200	8 X 200m	1.2	8.0	8.0	200	38.0	122.0
1PHS-095200	9.5 X 200m	1.6	10.0	9.5	200	38.0	122.0
1PHS-095250	9.5 X 250m	1.6	10.0	9.5	250	38.0	122.0
1PHS-095300	9.5 X 300m	1.6	9.5	9.5	300	38.0	122.0

► Go Thru Phillips Screwdriver

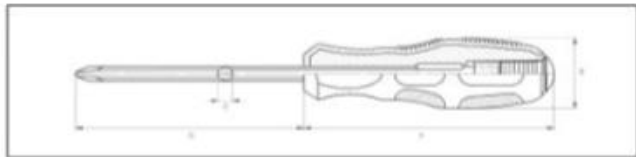

Part No.	Size	C	D	E	F
1PHF-0175	#1 X 75mm	5.0	75	31.0	100.0
1PHF-02100	#2 X 100mm	6.0	100	34.0	110.0
1PHF-02150	#2 X 150mm	6.0	150	34.0	110.0
1PHF-03150	#3 X 150mm	8.0	150	38.0	122.0
1PHF-03200	#3 X 200mm	8.0	200	38.0	122.0
1PHF-04200	#4 X 200mm	9.5	200	38.0	122.0
1PHF-04250	#4 X 250mm	9.5	250	38.0	122.0
1PHF-04300	#4 X 300mm	9.5	300	38.0	122.0



WARNING!

Wear safety goggles at all time. [User and bystanders]. Do not use chrome or handtools with power wrenches. Use only impact sockets and accessories with power impact wrenches.

SCREWDRIVER

► Go Thru Pozi Screwdriver



Part No.	Size	C	D	E	F
1PHZ-0175	#1 X 75mm	5.0	75	31.0	100.0
1PHZ-02100	#2 X 100mm	6.0	100	34.0	110.0
1PHZ-02150	#2 X 150mm	6.0	150	34.0	110.0
1PHZ-03150	#3 X 150mm	8.0	150	38.0	122.0
1PHZ-04200	#4 X 200mm	9.5	200	38.0	122.0



WARNING!

Wear safety goggles at all time. [User and bystanders]. Do not use chrome or handtools with power wrenches
Use only impact sockets and accessories with power impact wrenches



**PIPE
WRENCH**

PIPE WRENCH



► Heavy Duty Pipe Wrench

Part No.	Overall Length		Capacity		Max. Open Width	
PPW-10034	10"	250mm	1/4" - 1"	18 - 34mm	1"	34mm
PPW-12042	12"	300mm	1/2" - 1-1/4"	22 - 42mm	1-1/4"	42mm
PPW-14048	14"	350mm	1/2" - 1-1/2"	22 - 48mm	1-1/2"	48mm
PPW-18060	18"	450mm	1" - 2"	34 - 60mm	2"	60mm

- * Quick & Easy Operation
- * Self Adjusting To Pipe Size
- * Powerful Grip

► Instruction To Use:



Push the thumb trigger downwards to open the jaw.



Fit the jaw around the pipe and release the thumb trigger to operate.



To release the pipe push the thumb trigger downward.



WARNING!

Wear safety goggles at all time. [User and bystanders]. Do not use chrome or handtools with power wrenches. Use only impact sockets and accessories with power impact wrenches.



CONVERSION TABLES

CONVERSION TABLES

Sizes		1"	2"	3"	4"	5"	6"	7"	8"	9"	10"
AF	MM	25.400	50.800	76.200	101.600	127.000	152.400	177.800	203.200	228.600	254.000
1/64	0.397	25.797	51.197	76.597	101.997	127.397	152.797	178.197	203.597	228.997	254.397
1/32	0.794	26.194	51.594	76.994	102.394	127.794	153.194	178.594	203.994	229.394	254.794
3/64	1.191	26.591	51.991	77.391	102.791	128.191	153.591	178.991	204.391	229.791	255.191
1/20	1.270	26.670	52.070	77.470	102.870	128.270	153.670	179.070	204.470	229.870	255.270
1/16	1.588	26.988	52.388	77.788	103.188	128.588	153.988	179.388	204.788	230.188	255.588
5/64	1.984	27.384	52.784	78.184	103.584	128.984	154.384	179.784	205.184	230.584	255.984
3/32	2.381	27.781	53.181	78.581	103.981	129.381	154.781	180.181	205.581	230.981	256.381
7/64	2.778	28.178	53.578	78.978	104.378	129.778	155.178	180.578	205.978	231.378	256.778
1/8	3.175	28.575	53.975	79.375	104.775	130.175	155.575	180.975	206.375	231.775	257.175
9/64	3.572	28.972	54.372	79.772	105.172	130.572	155.972	181.372	206.772	232.172	257.572
5/32	3.969	29.369	54.769	80.169	105.569	130.969	156.369	181.769	207.169	232.569	257.969
11/64	4.366	29.766	55.166	80.566	105.966	131.366	156.766	182.166	207.566	232.966	258.366
3/16	4.763	30.163	55.563	80.963	106.363	131.763	157.163	182.563	207.963	233.363	258.763
13/64	5.159	30.559	55.959	81.359	106.759	132.159	157.559	182.959	208.359	233.759	259.159
7/32	5.556	30.956	56.356	81.756	107.156	132.556	157.956	183.356	208.756	234.156	259.556
15/64	5.953	31.353	56.753	82.153	107.553	132.953	158.353	183.753	209.153	234.553	259.953
1/4	6.350	31.750	57.150	82.550	107.950	133.350	158.750	184.150	209.550	234.950	260.350
17/64	6.747	32.147	57.547	82.947	108.347	133.747	159.147	184.547	209.947	235.347	260.747
9/32	7.144	32.544	57.944	83.344	108.744	134.144	159.544	184.944	210.344	235.744	261.144
19/64	7.541	32.941	58.341	83.741	109.141	134.541	159.941	185.341	210.741	236.141	261.541
5/16	7.938	33.338	58.738	84.138	109.538	134.938	160.338	185.738	211.138	236.538	261.938
21/64	8.334	33.734	59.134	84.534	109.934	135.334	160.734	186.134	211.534	236.934	262.334
11/32	8.731	34.131	59.531	84.931	110.331	135.731	161.131	186.531	211.931	237.331	262.731
23/64	9.128	34.528	59.928	85.328	110.728	136.128	161.528	186.928	212.328	237.728	263.128
3/8	9.525	34.925	60.325	85.725	111.125	136.525	161.925	187.325	212.725	238.125	263.525
25/64	9.922	35.322	60.722	86.122	111.522	136.922	162.322	187.722	213.122	238.522	263.922
13/32	10.319	35.719	61.119	86.519	111.919	137.319	162.719	188.119	213.519	238.919	264.319
27/64	10.716	36.116	61.516	86.916	112.316	137.716	163.116	188.516	213.916	239.316	264.716
7/16	11.113	36.513	61.913	87.313	112.713	138.113	163.513	188.913	214.313	239.713	265.113
29/64	11.509	36.909	62.309	87.709	113.109	138.509	163.909	189.309	214.709	240.109	265.509
15/32	11.906	37.306	62.706	88.106	113.506	138.906	164.306	189.706	215.106	240.506	265.906
31/64	12.303	37.703	63.103	88.503	113.903	139.303	164.703	190.103	215.503	240.903	266.303
1/2	12.700	38.100	63.500	88.900	114.300	139.700	165.100	190.500	215.900	241.300	266.700
33/64	13.097	38.497	63.897	89.297	114.697	140.097	165.497	190.897	216.297	241.697	267.097
17/32	13.494	38.894	64.294	89.694	115.094	140.494	165.894	191.294	216.694	242.094	267.494
35/64	13.891	39.291	64.691	90.091	115.491	140.891	166.291	191.691	217.091	242.491	267.891
9/16	14.288	39.688	65.088	90.488	115.888	141.288	166.688	192.088	217.488	242.888	268.288



WARNING!

Wear safety goggles at all time. [User and bystanders]. Do not use chrome or handtools with power wrenches. Use only impact sockets and accessories with power impact wrenches.

CONVERSION TABLES

Sizes	1"	2"	3"	4"	5"	6"	7"	8"	9"	10"	
37/64	14.684	40.084	65.484	90.884	116.284	141.684	167.084	192.484	217.884	243.284	268.684
19/32	15.081	40.481	65.881	91.281	116.681	142.081	167.481	192.881	218.281	243.681	269.081
39/64	15.478	40.878	66.278	91.678	117.078	142.478	167.878	193.278	218.678	244.078	269.478
5/8	15.875	41.275	66.675	92.075	117.475	142.875	168.275	193.675	219.075	244.475	269.875
41/64	16.272	41.672	67.072	92.472	117.872	143.272	168.672	194.072	219.472	244.872	270.272
21/32	16.669	42.069	67.469	92.869	118.269	143.669	169.069	194.469	219.869	245.269	270.669
43/64	17.066	42.466	67.866	93.266	118.666	144.066	169.466	194.866	220.266	245.666	271.066
11/16	17.463	42.863	68.263	93.663	119.063	144.463	169.863	195.263	220.663	246.063	271.463
45/64	17.859	43.259	68.659	94.059	119.459	144.859	170.259	195.659	221.059	246.459	271.859
23/32	18.256	43.656	69.056	94.456	119.856	145.256	170.656	196.056	221.456	246.856	272.256
47/64	18.653	44.053	69.453	94.853	120.253	145.653	171.053	196.453	221.853	247.253	272.653
3/4	19.050	44.450	69.850	95.250	120.650	146.050	171.450	196.850	222.250	247.650	273.050
49/64	19.447	44.847	70.247	95.647	121.047	146.447	171.847	197.247	222.647	248.047	273.447
25/32	19.844	45.244	70.644	96.044	121.444	146.844	172.244	197.644	223.044	248.444	273.844
51/64	20.241	45.641	71.041	96.441	121.841	147.241	172.641	198.041	223.441	248.841	274.241
13/16	20.638	46.038	71.438	96.838	122.238	147.638	173.038	198.438	223.838	249.238	274.638
53/64	21.034	46.434	71.834	97.234	122.634	148.034	173.434	198.834	224.234	249.634	275.034
27/32	21.431	46.831	72.231	97.631	123.031	148.431	173.831	199.231	224.631	250.031	275.431
55/64	21.828	47.228	72.628	98.028	123.428	148.828	174.228	199.628	225.028	250.428	275.828
7/8	22.225	47.625	73.025	98.425	123.825	149.225	174.625	200.025	225.425	250.825	276.225
57/64	22.622	48.022	73.422	98.822	124.222	149.622	175.022	200.422	225.822	251.222	276.622
29/32	23.019	48.419	73.819	99.219	124.619	150.019	175.419	200.819	226.219	251.619	277.019
59/64	23.416	48.816	74.216	99.616	125.016	150.416	175.816	201.216	226.616	252.016	277.416
15/16	23.813	49.213	74.613	100.013	125.413	150.813	176.213	201.613	227.013	252.413	277.813
61/64	24.209	49.609	75.009	100.409	125.809	151.209	176.609	202.009	227.409	252.809	278.209
31/32	24.606	50.006	75.406	100.806	126.206	151.606	177.006	202.406	227.806	253.206	278.606
63/64	25.003	50.403	75.803	101.203	126.603	152.003	177.403	202.803	228.203	253.603	279.003



WARNING!

Wear safety goggles at all time. (User and bystanders). Do not use chrome or handtools with power wrenches. Use only impact sockets and accessories with power impact wrenches.



Distributed by



